

# 1814G with FilterQuick™

## Gas Fryer

### Installation, Operation and Maintenance Manual

This manual is updated as new information and models are released. Visit our website for the latest manual.



#### FOR YOUR SAFETY

Do Not Store or use gasoline or other flammable vapors and liquids in the vicinity of this or any other appliance.



**READ THE INSTRUCTIONS BEFORE USING THE FRYER.**



8 1 9 7 3 7 1

Part Number: FRY\_IOM\_8197371 03/2018

Original Instructions

**NOTICE**

IF, DURING THE WARRANTY PERIOD, THE CUSTOMER USES A PART FOR THIS FRYMASTER FOOD SERVICE EQUIPMENT OTHER THAN AN **UNMODIFIED** NEW OR RECYCLED PART PURCHASED DIRECTLY FROM FRYMASTER OR ANY OF ITS AUTHORIZED SERVICERS, AND/OR THE PART BEING USED IS MODIFIED FROM ITS ORIGINAL CONFIGURATION, THIS WARRANTY WILL BE VOID. FURTHER, FRYMASTER AND ITS AFFILIATES WILL NOT BE LIABLE FOR ANY CLAIMS, DAMAGES OR EXPENSES INCURRED BY THE CUSTOMER WHICH ARISE DIRECTLY OR INDIRECTLY, IN WHOLE OR IN PART, DUE TO THE INSTALLATION OF ANY MODIFIED PART AND/OR PART RECEIVED FROM AN UNAUTHORIZED SERVICER.

**NOTICE**

This appliance is intended for professional use only and is to be operated by qualified personnel only. A Frymaster Factory Authorized Servicer (FAS) or other qualified professional should perform installation, maintenance, and repairs. Installation, maintenance, or repairs by unqualified personnel may void the manufacturer's warranty. See Chapter 1 of this manual for definitions of qualified personnel.

**NOTICE**

This equipment must be installed in accordance with the appropriate national and local codes of the country and/or region in which the appliance is installed. See NATIONAL CODE REQUIREMENTS in Chapter 2 of this manual for specifics.

**NOTICE TO U.S. CUSTOMERS**

This equipment is to be installed in compliance with the basic plumbing code of the Building Officials and Code Administrators International, Inc. (BOCA) and the Food Service Sanitation Manual of the U.S. Food and Drug Administration.

**NOTICE**

Drawings and photos used in this manual are intended to illustrate operational, cleaning and technical procedures and may not conform to onsite management operational procedures.

**NOTICE**

This appliance is intended to be used for commercial applications, for example in kitchens of restaurants, canteens, hospitals and in commercial enterprises such as bakeries, butcheries, etc., but not for continuous mass production of food.

**NOTICE TO OWNERS OF UNITS EQUIPPED WITH CONTROLLERS**

**U.S.**

This device complies with Part 15 of the FCC rules. Operation is subject to the following two conditions: 1) This device may not cause harmful interference, and 2) This device must accept any interference received, including interference that may cause undesired operation. While this device is a verified Class A device, it has been shown to meet the Class B limits.

**CANADA**

This digital apparatus does not exceed the Class A or B limits for radio noise emissions as set out by the ICES-003 standard of the Canadian Department of Communications.

 **DANGER**

Improper installation, adjustment, maintenance or service, and unauthorized alterations or modifications can cause property damage, injury, or death. Read the installation, operating, and service instructions thoroughly before installing or servicing this equipment. Only qualified service personnel may convert this appliance to use a gas other than that for which it was originally configured.

 **DANGER**

No structural material on the fryer should be altered or removed to accommodate placement of the fryer under a hood. Questions? Call the Frymaster Service Hotline at 1-800-551-8633.

 **WARNING**

After installation of a gas fryer and after any maintenance to the gas system of a gas fryer-manifold, valve, burners, etc. – check for gas leaks at all connections. Apply a thick soapy solution to all connections and ensure there are no bubbles. There should be no smell of gas.

**NOTICE**

The Commonwealth of Massachusetts requires any and all gas products to be installed by a licensed plumber or pipe fitter.

 **DANGER**

Instructions to be followed in the event the operator smells gas or otherwise detects a gas leak must be posted in a prominent location. This information can be obtained from the local gas company or gas supplier.

 **DANGER**

Adequate means must be provided to limit the movement of this appliance without depending upon the gas line connection. Single fryers equipped with legs must be stabilized by installing anchor straps. All fryers equipped with casters must be stabilized by installing restraining chains. If a flexible gas line is used, an additional restraining cable must be connected at all times when the fryer is in use.

 **CAUTION**

No warranty is provided for any Frymaster fryer used in a mobile or marine installation or concession. Warranty protection is only offered for fryers installed in accordance with the procedures described in this manual. Mobile, marine or concession conditions of this fryer should be avoided to ensure optimum performance.

 **DANGER**

The front ledge of the fryer is not a step! Do not stand on the fryer. Serious injury can result from slips or contact with the hot oil.

 **DANGER**

Do not store or use gasoline or other flammable liquids or vapors in the vicinity of this or any other appliance.

 **DANGER**

Do not spray aerosols in the vicinity of this appliance while it is in operation.

 **DANGER**

This product contains chemicals known to the state of California to cause cancer and/or birth defects or other reproductive harm.

Operation, installation, and servicing of this product could expose you to airborne particles of glasswool or ceramic fibers, crystalline silica, and/or carbon monoxide. Inhalation of airborne particles of glasswool or ceramic fibers is known to the State of California to cause cancer. Inhalation of carbon monoxide is known to the State of California to cause birth defects or other reproductive harm.

 **DANGER**

The crumb tray in fryers equipped with a filter system must be emptied into a fireproof container at the end of frying operations each day. Some food particles can spontaneously combust if left soaking in certain shortening material.

 **WARNING**

Do not bang fry baskets or other utensils on the fryer's joiner strip. The strip is present to seal the joint between the fry vessels. Banging fry baskets on the strip to dislodge shortening will distort the strip, adversely affecting its fit. It is designed for a tight fit and should only be removed for cleaning.

 **WARNING**

This appliance is not intended for use by children under the age of 16 or persons with reduced physical, sensory or mental capabilities, or lack of experience and knowledge, unless they have been given supervision concerning use of the appliance by a person responsible for their safety. Do not allow children to play with this appliance.

**NOTICE**

The appliance must be installed and used in such a way that any water cannot contact the fat or oil.

 **DANGER**

Keep all items out of drains. Closing actuators may cause damage or injury.

 **DANGER**

Prior to movement, testing, maintenance and any repair on your Frymaster fryer; disconnect ALL electrical power cords from the electrical power supply.

 **WARNING**

If the electrical power supply cord is damaged, it must be replaced by a Frymaster Factory Authorized Servicer or a similarly qualified person in order to avoid a hazard.

 **WARNING**

Use caution and wear appropriate safety equipment to avoid contact with hot oil or surfaces that may cause severe burns or injury.

 **WARNING**

**NEVER** drain boil out or cleaning solution into a shortening disposal unit (SDU), a built-in filtration unit, a portable filter unit, or an OQS (Oil Quality Sensor). These units are not intended for this purpose, and will be damaged by the solution and void the warranty.



# 1814G with FilterQuick™ Series Gas Fryers Installation and Operation Manual

## TABLE OF CONTENTS

---

### CHAPTER 1: Introduction

1.1	Applicability and Validity.....	1-1
1.2	Safety Information .....	1-1
1.3	Controller Information.....	1-2
1.4	European Community (CE) Specific Information .....	1-2
1.5	Equipment Description .....	1-3
1.5.1	Principles of Operation .....	1-3
1.6	Installation, Operating, and Service Personnel.....	1-3
1.7	Definitions.....	1-3
1.8	Shipping Damage Claim Procedure .....	1-4
1.9	Rating Plate .....	1-4
1.10	Reading Model Numbers.....	1-5
1.11	Parts Ordering and Service Information.....	1-5

### CHAPTER 2: Installation Instructions

2.1	General Installation Requirements.....	2-1
2.1.1	Clearance and Ventilation.....	2-2
2.1.2	National Code Requirements.....	2-3
2.1.2.1	Installation Standard.....	2-3
2.1.3	Power Requirements .....	2-4
2.1.4	Electrical Grounding Requirements .....	2-4
2.1.5	Australian Requirements.....	2-4
2.2	Caster/Leg Installation.....	2-5
2.3	Pre-Connection Preparations.....	2-5
2.4	Connection to Gas Line .....	2-6
2.4.1	Gas Specifications .....	2-7
2.4.2	Equipment Installed at High Altitudes .....	2-10
2.5	Converting to another Gas Type.....	2-10
2.6	Positioning the Fryer .....	2-11
2.7	Installing the Oil Saddle Reservoir.....	2-12

### CHAPTER 3: Operating Instructions

3.1	Controller Operation and Programming.....	3-2
3.2	Equipment Setup and Start-Up Procedures.....	3-2
3.2.1	Setup .....	3-2
3.2.2	Lighting the Fryer .....	3-3
3.3	Shutting the Fryer Down .....	3-4
3.4	Oil Attendant® Automatic Top-off.....	3-5
3.4.1	Adding Oil to the Oil Saddle Reservoir .....	3-5
3.4.2	Routine Oil Changes .....	3-6
3.4.3	Bulk Oil Systems .....	3-6

### CHAPTER 4: Filtration Instructions

4.1	Introduction .....	4-1
4.2	Preparation for Use with Filter Paper or Filter Pad .....	4-1

4.3	FilterQuick™ with Fingertip Filtration .....	4-2
4.4	Troubleshooting FilterQuick™ with Fingertip Filtration .....	4-3
4.4.1	Incomplete Filtration.....	4-3
4.5	Filter Busy .....	4-4
4.6	Draining and Refilling Vats, and Disposing of Waste Oil.....	4-5
<b>CHAPTER 5: Preventive Maintenance</b>		
5.1	Cleaning the Fryer .....	5-1
5.2	Daily Checks and Service.....	5-1
5.2.1	Inspect Fryer for Damage .....	5-1
5.2.2	Clean Fryer Cabinet Inside and Out .....	5-1
5.2.3	Clean the FilterQuick™ Filtration System.....	5-1
5.2.4	Clean Detachable Parts and Accessories.....	5-2
5.2.5	Clean Oil Level Float Switch.....	5-2
5.3	Weekly Checks and Service .....	5-2
5.3.1	Drain and Clean Frypot.....	5-2
5.3.2	Boiling Out/Cold Soak the Frypot.....	5-2
5.3.3	Cleaning the Oil Saddle Reservoir .....	5-4
5.4	Monthly Checks and Service .....	5-4
5.4.1	Check FilterQuick™ Controller Setpoint Accuracy.....	5-4
5.5	Quarterly Checks and Service .....	5-4
5.5.1	Replace O-rings .....	5-4
5.6	Semi-Annual Checks and Service .....	5-5
5.6.1	Clean Gas Valve Vent Tube.....	5-5
5.6.2	Check Burner Manifold Pressure .....	5-5
5.7	Annual/Periodic System Inspection .....	5-5
5.7.1	Fryer .....	5-5
5.7.2	1814G with FilterQuick™ Filtration System.....	5-6
5.7.3	Stainless Steel Care .....	5-6
<b>CHAPTER 6: Operator Troubleshooting</b>		
6.1	Introduction.....	6-1
6.2	Troubleshooting.....	6-2
6.2.1	Controller and Heating Problems.....	6-2
6.2.2	Error Message and Display Problems .....	6-3
6.2.3	Basket Lift Problems .....	6-4
6.2.4	Filtration Problems.....	6-4
6.2.5	Auto Top Off Problems.....	6-6
6.2.6	Error Log Codes.....	6-6
6.2.7	OQS (Oil Quality Sensor) .....	6-8
<b>APPENDIX A: Bulk Oil Instructions</b>		

# 1814G with FILTERQUICK™ SERIES GAS FRYER

## CHAPTER 1: GENERAL INFORMATION

---

**NOTE:** The Frymaster1814G with FilterQuick™ fryer requires a start-up, demonstration and training before normal restaurant operations can begin.

### 1.1 Applicability and Validity

The 1814G with FilterQuick™ Series Gas Fryer, with SMART4U® technology, has been approved by the European Union for sale and installation in the following EU countries: AT, BE, DE, DK, ES, FI, FR, GB, IE, IT, LU, NL, NO, PT and SE.

This manual is applicable to and valid for all 1814G with FilterQuick™ Series Gas Fryers sold in English-speaking countries, including those in the European Union. Where conflicts exist between instructions and information in this manual and local or national codes of the country in which the equipment is installed, installation and operation shall comply with those codes.

This appliance is only for professional use and shall be used by qualified personnel only, as defined in Section 1.7.

### 1.2 Safety Information

Before attempting to operate your unit, read the instructions in this manual thoroughly. Throughout this manual, you will find notations enclosed in double-bordered boxes similar to the ones that follow.



**DANGER**

**HOT OIL CAUSES SEVERE BURNS. NEVER ATTEMPT TO MOVE A FRYER CONTAINING HOT OIL OR TO TRANSFER HOT OIL FROM ONE CONTAINER TO ANOTHER.**

 **CAUTION** boxes contain information about actions or conditions that *may cause or result in a malfunction of your system*.

 **WARNING** boxes contain information about actions or conditions that *may cause or result in damage to your system*, and which may cause your system to malfunction.

 **DANGER** boxes contain information about actions or conditions that *may cause or result in injury to personnel*, and which may cause damage to your system and/or cause your system to malfunction.

Your fryer is equipped with automatic safety features:

1. High temperature detection shuts off gas to the burner assembly should the controlling thermostat fail.

2. An optional safety switch built into the drain valve prevents burner ignition with the drain valve even partially open.
3. A safety float switch prevents the burners from operating if no oil is present in the fryer.

### 1.3 Controller Information

#### FCC COMPLIANCE

This equipment has been tested and found to comply with the limits for a Class A digital device, pursuant to Part 15 of the FCC rules. While this device is a verified Class A device, it has been shown to meet the Class B limits. These limits are designed to provide reasonable protection against harmful interference when the equipment is operated in a commercial environment. This equipment generates, uses and can radiate radio frequency energy and, if not installed and used in accordance with the instruction manual, may cause harmful interference to radio communications.

Operation of the equipment in a residential area is likely to cause harmful interference in which case the user will be required to correct the interference at their own expense.

The user is cautioned that any changes or modifications not expressly approved by the party responsible for compliance could void the user's authority to operate the equipment.

If necessary, the user should consult the dealer or an experienced radio and television technician for additional suggestions.

The user may find the following booklet prepared by the Federal Communications Commission helpful: "How to Identify and Resolve Radio-TV Interference Problems". This booklet is available from the U.S. Government Printing Office, Washington, DC 20402, Stock No. 004-000-00345-4.

### 1.4 European Community (CE) Specific Information

The European Community (CE) has established certain specific standards regarding equipment of this type. Whenever a conflict exists between CE and non-CE standards, the information or instructions concerned are identified by means of shadowed boxes similar to the one below.

<b>Non-CE Standard for Incoming Gas Pressures</b>		
<b>Type</b>	<b>Minimum</b>	<b>Maximum</b>
Natural	6" W.C.	14" W.C.
	1.49 kPa	3.49 kPa
	14.68 mbar	34.72 mbar
LP	11" W.C.	14" W.C.
	2.74 kPa	3.49 kPa
	27.28 mbar	34.84 mbar



## 1.5 Equipment Description

1814G with FilterQuick™ Series gas fryers are energy efficient, tube-style, gas fired fryers. These models have a built-in FilterQuick™ fingertip filtration system.

All 1814G with FilterQuick™ Series Gas Fryers are of an open-frypot design with no tubes and have a hand-sized opening into the cold zone, which makes cleaning the stainless frypot quick and easy.

1814G with FilterQuick™ Series Gas Fryers can be configured for natural gas or propane (LP gas, as required by the customer).

Each frypot is equipped with a temperature probe for precise temperature control.

All 1814G with FilterQuick™ Series Gas Fryers come standard with electronic ignition and melt cycle mode. The 1814G with FilterQuick™ Series Gas Fryers are controlled with a FilterQuick™ controller.

All fryers in this series require an external source of AC electrical power. Units can be configured for voltages ranging from 100 VAC to 240 VAC.

FilterQuick™ FQG30 Series fryers are shipped completely assembled. All fryers are shipped with a package of standard accessories. Each fryer is adjusted, tested, and inspected at the factory before crating for shipment.

### 1.5.1 Principles of Operation

The incoming gas flows through orifices and is mixed with air in the burners to create the correct ratio for proper combustion. The mixture is ignited at the front end of each heat tube by the pilot light. Internal diffusers slow the flame as it goes through the burner tube. This slow, turbulent flame increases heat transfer to the walls of the tubes to heat the oil more efficiently.

## 1.6 Installation, Operating, and Service Personnel

Operating information for Frymaster equipment has been prepared for use by qualified and/or authorized personnel only, as defined in Section 1.7. **All installation and service on Frymaster equipment must be performed by qualified, certified, licensed, and/or authorized installation or service personnel, as defined in Section 1.7.**

## 1.7 Definitions

### QUALIFIED AND/OR AUTHORIZED OPERATING PERSONNEL

Qualified/authorized operating personnel are those who have carefully read the information in this manual and have familiarized themselves with the equipment functions, or who have had previous experience with the operation of the equipment covered in this manual.

## QUALIFIED INSTALLATION PERSONNEL

Qualified installation personnel are individuals, firms, corporations, and/or companies which, either in person or through a representative, are engaged in and are responsible for the installation of gas-fired appliances. Qualified personnel must be experienced in such work, be familiar with all gas precautions involved, and have complied with all requirements of applicable national and local codes.

## QUALIFIED SERVICE PERSONNEL

Qualified service personnel are those who are familiar with Frymaster equipment and who have been authorized by Frymaster, L.L.C. to perform service on the equipment. All authorized service personnel are required to be equipped with a complete set of service and parts manuals, and to stock a minimum amount of parts for Frymaster equipment. A list of Frymaster Factory Authorized Servicicers (FAS's) is located on the Frymaster website at [www.frymaster.com/service](http://www.frymaster.com/service). **Failure to use qualified service personnel will void the Frymaster warranty on your equipment.**

### 1.8 Shipping Damage Claim Procedure

Your Frymaster equipment was carefully inspected and packed before leaving the factory. The transportation company assumes full responsibility for safe delivery upon its acceptance of the equipment for transport.

#### What to do if your equipment arrives damaged:

1. **File a claim for damages immediately**, regardless of the extent of damages.
2. **Inspect for and record all visible loss or damage**, and ensure that this information is noted on the freight bill or express receipt and is signed by the person making the delivery.
3. **Concealed loss or damage** that was unnoticed until the equipment was unpacked should be recorded and reported to the freight company or carrier **immediately** upon discovery. A concealed damage claim must be submitted within 15 days of the date of delivery. Ensure that the shipping container is retained for inspection.

**Frymaster DOES NOT ASSUME RESPONSIBILITY FOR DAMAGE OR LOSS  
INCURRED IN TRANSIT.**

### 1.9 Rating Plate

This is attached to the inside front door panel. Information provided includes the model and serial number of the fryer, BTU/hr input of the burners, outlet gas pressure in inches W.C. and whether the unit has natural or propane gas orifices.

**1.10 Reading Model Numbers**

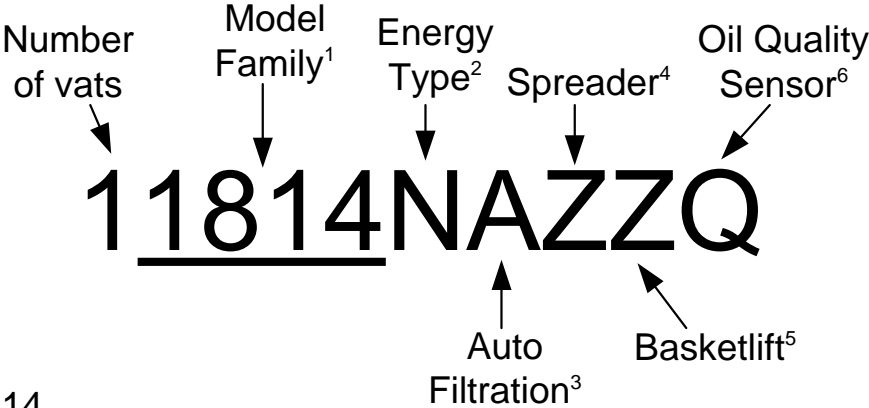

- 1 = 1814
- 2 = E-Electric, N-Natural Gas, P-Propane Gas
- 3 = A-Auto Filtration
- 4 = S-Spreader; Z-none
- 5 = B-Basket Lift; Z-none
- 6 = Q-Oil Quality Sensor; Z-none

**1.11 Parts Ordering and Service Information**

In order to assist you quickly, the Frymaster Factory Authorized Servicer (FAS) or Service Department representative requires certain information about your equipment. Most of this information is printed on a data plate affixed to the inside of the fryer door. Part numbers are found in the Parts Manual. Parts orders may be placed directly with your local FAS or distributor. A list of Frymaster Factory Authorized Servicers (FAS's) is located on the Frymaster website at [www.frymaster.com/service](http://www.frymaster.com/service). If you do not have access to this list, contact the Frymaster Service Department at 1-800-551-8633 or 1-318-865-1711 or by e-mail: [service@frymaster.com](mailto:service@frymaster.com).

Service information may be obtained by contacting your local FAS/Distributor. Service may also be obtained by calling the Frymaster Service Department at 1-800-551-8633 or 1-318-865-1711 or by e-mail: [service@frymaster.com](mailto:service@frymaster.com). When requesting parts or service, please have the following information ready:

Model Number: \_\_\_\_\_  
 Serial Number: \_\_\_\_\_  
 Type of Gas and voltage: \_\_\_\_\_  
 Item Part Number: \_\_\_\_\_  
 Quantity Needed: \_\_\_\_\_

In addition to the model number, serial number, and type of gas, please be prepared to describe the nature of the problem and have ready any other information that you think may be helpful in solving your problem.

**RETAIN AND STORE THIS MANUAL IN A SAFE PLACE FOR FUTURE USE.**

# 1814G with FILTERQUICK™ SERIES GAS FRYER

## CHAPTER 2: INSTALLATION INSTRUCTIONS

---

### 2.1 General Installation Requirements

Qualified, licensed, and/or authorized installation or service personnel, as defined in Section 1.7 of this manual, should perform all installation and service on Frymaster equipment.

Conversion of this appliance from one type of gas to another should only be performed by qualified, licensed, and/or authorized installation or service personnel as defined in Section 1.7 of this manual.

Failure to use qualified, licensed, and/or authorized installation or service personnel (as defined in Section 1.7 of this manual) to install, convert to another gas type or otherwise service this equipment will void the Frymaster warranty and may result in damage to the equipment or injury to personnel.

Where conflicts exist between instructions and information in this manual and local or national codes or regulations, installation and operation shall comply with the codes or regulations in force in the country in which the equipment is installed.

Parts protected by the manufacturer or its agent shall not be adjusted by the installer.

 **DANGER**

**Building codes prohibit a fryer with its open tank of hot oil being installed beside an open flame of any type, including those of broilers and ranges.**

Upon arrival, inspect the fryer carefully for visible or concealed damage. (See **Shipping Damage Claim Procedure** in Chapter 1.)

#### 2.1.1 Clearance and Ventilation

The fryer(s) must be installed with a 6" (150 mm) clearance at both sides and back when installed adjacent to combustible construction; no clearance is required when installed adjacent to noncombustible construction. A minimum of 24" (600 mm) clearance should be provided at the front of the fryer.

 **WARNING**

**Do not block the area around the base or under the fryers**

The fryer(s) must be installed on non-combustible floors equipped with factory-supplied 6 in. (15 cm) adjustable legs or 5 in. (13 cm) casters.

 **DANGER**

**No structural material on the fryer should be altered or removed to accommodate placement of the fryer under a hood. Questions? Call the Frymaster Service Hotline at 1-800-551-8633.**

One of the most important considerations of efficient fryer operation is ventilation. Make sure the fryer is installed so that products of combustion are removed efficiently, and that the kitchen ventilation system does not produce drafts that interfere with burner operation.

A commercial, heavy-duty fryer must vent its combustion wastes to the outside of the building. A deep-fat fryer must be installed under a powered exhaust hood, as exhaust gas temperatures are approximately 800-1000°F (427-538°C). Check air movement during installation. Strong exhaust fans in the exhaust hood or in the overall air conditioning system can produce slight air drafts in the room.

Do not place the fryer's flue outlet directly into the plenum of the hood, as it will affect the gas combustion of the fryer. The fryer flue opening must not be placed close to the intake of the exhaust fan, and the fryer must never have its flue extended in a "chimney" fashion. An extended flue will change the combustion characteristics of the fryer, causing longer recovery time. It also frequently causes delayed ignition. To provide the airflow necessary for good combustion and burner operation, the areas surrounding the fryer front, sides, and rear must be kept clear and unobstructed.

 **DANGER**

**This appliance must be installed with sufficient ventilation to prevent the occurrence of unacceptable concentrations of substances harmful to the health of personnel in the room in which it is installed.**

Fryers must be installed in an area with an adequate air supply and adequate ventilation. Adequate distances must be maintained from the flue outlet of the fryer to the lower edge of the ventilation filter bank. Filters should be installed at an angle of 45°. Place a drip tray beneath the lowest edge of the filter. For U.S. installation, NFPA standard No. 96 states, "A minimum distance of 18 in. (450 mm) should be maintained between the flue outlet and the lower edge of the grease filter." *Frymaster recommends that the minimum distance be 24 in. (600 mm) from the flue outlet to the bottom edge of the filter when the appliance consumes more than 120,000 BTU per hour.*

For installations in the United States, information on construction and installation of ventilating hoods can be found in the NFPA standard cited above. A copy of the standard may be obtained from the National Fire Protection Association, Battery March Park, Quincy, MA 02269.

Never use the interior of the fryer cabinet for storage or store items on shelving over or behind the fryer. Exhaust temperatures can exceed 800°F (427°C) and may damage or melt items stored in or near the fryer.

## 2.1.2 National Code Requirements

The type of gas for which the fryer is equipped is stamped on the data plate attached to the inside of the fryer door. Connect a fryer stamped "NAT" only to natural gas, those stamped "PRO" only to propane gas, and those stamped "MFG" only to manufactured gas.

Installation shall be made with a gas connector that complies with national and local codes, and, where applicable, CE codes. A manual gas shut-off valve must be installed in the gas supply line ahead of the fryers for safety and ease of future service. Ensure the shut-off valve is in a position where it can be reached quickly in the event of an emergency. Quick-disconnect devices, if used, shall likewise comply with national, local, and, if applicable, CE codes. In the absence of local codes, installation must conform to the national Fuel Gas Code, ANSI Z223.1/NFPA 54 or the Natural Gas and Propane Installation code, CSA B149.1, as applicable including:

1. The appliance and its individual shutoff valve must be disconnected from the gas supply piping system during any pressure testing of the system at test pressures in excess of ½ psi (3.5 kPa).
2. The appliance must be isolated from the gas supply piping system by closing its individual manual shutoff valve during any pressure testing of the gas supply piping system at test pressures equal to or less than ½ psi (3.5 kPa).

### 2.1.2.1 Installation Standards

<p>1. <u>U.S. installations must meet:</u></p> <p>American National Standard Institute ANSI Z83.11 American Gas Association 8501 E. Pleasant Valley Road Cleveland, OH 44131</p> <p>National Electrical Code ANSI/NFPA #70 American National Standard Institute 1430 Broadway New York, NY 10018</p> <p>NFPA Standards #96 and #211 National Fire Protection Association 470 Atlantic Avenue Boston, MA 02110</p>	<p>2. <u>Canadian installations must meet:</u></p> <p>CAN 1-B149 Installation Codes Canadian Gas Association 55 Scarsdale Road Don Mills, ONT, M3B 2R3</p> <p>Canadian Electric Code c22.1, part 1 Canadian Standards Association 178 Rexdale Blvd. Rexdale, ONT, M9W 1R3</p>
<p>3. <u>CE/Export Standards:</u> Fryer installation must conform with local codes, or, in the absence of local codes, to the appropriate national or European Community (CE) standards.</p>	

### 2.1.3 Power Requirements

Frymaster 1814G with FilterQuick Series gas fryers require 120VAC 60 cycle or 230VAC single-phase 50 Hz (International) electrical service and are equipped with a 16-3 SJT grounded flexible power cord for a direct connection to the power supply. Amperage draw for each unit depends on the accessories supplied with the unit/system.

 **DANGER**

**This appliance must be connected to a power supply having the same voltage and phase as specified on the rating plate located on the inside of the appliance door.**

If the supply cord is damaged, it must be replaced by the manufacturer, its service agent or similarly qualified persons in order to avoid a hazard.

### 2.1.4 Electrical Grounding Requirements

All electrically operated appliances must be grounded in accordance with all applicable national and local codes, and, where applicable, CE codes. In the absence of local codes, the appliance must be grounded in accordance with National Electrical Code, ANSI/NFPA 70, or the Canadian Electrical Code, CSA C22.2, as applicable. All units (cord connected or permanently connected) should be connected to a grounded power supply system. A wiring diagram is located on the inside of the fryer door. Refer to the rating plate on the inside of the fryer door for proper voltages.

The equipotential grounding lug allows all the equipment in the same location to be electrically connected to ensure there is no electrical potential difference between the units, which could be hazardous.



 **DANGER**

**This appliance is equipped with a special (grounding) plug for your protection against electrical shock, and must be plugged directly into a properly grounded receptacle. Do not cut, remove, or otherwise bypass the grounding prong on this plug!**

 **DANGER**

**This appliance requires electrical power for operation. Place the gas control valve in the OFF position in case of a prolonged power outage. Do not attempt to operate this appliance during a power outage.**

In the event of a power failure, the fryer(s) will automatically shut down. If this occurs, turn the power switch OFF. Do not attempt to start the fryer(s) until power is restored.

### 2.1.5 Australian Requirements

To be installed in accordance with AS 5601 and AS/NZS 3000:2007, local authorities, gas, electricity, and any other relevant statutory regulations.

If casters are fitted, the installation must comply with AS5601 and AS1869 requirements.

## 2.2 Caster/Leg Installation

Depending upon the specific configuration ordered, your fryer may have been shipped without installed casters or legs. **DO NOT INSTALL THIS APPLIANCE WITHOUT CASTERS OR LEGS. If the appliance requires the installation of casters or legs, install them in accordance with the instructions included in your accessory package.**

On an appliance with casters; the installation shall be made with a connector that complies with the Standard for Moveable Gas Appliances, ANSI Z21.69 • CSA 6.16, and a quick disconnect device that complies with the Standard for Quick-Disconnect Devices for Use With Gas Fuel, ANSI Z21.41 • CSA 6.9.

## 2.3 Pre-Connection Preparations

 **DANGER**

**DO NOT connect this appliance to the gas supply before completing each step in this section.**

After the fryer has been positioned under the exhaust hood, ensure the following has been accomplished:

1. Adequate means must be provided to limit the movement of fryers without depending upon the gas line connections. If a flexible gas hose is used, a restraining cable must be connected at all times when the fryer is in use. The restraining cable and installation instructions are packed with the flexible hose in the accessories box that was shipped with your unit.

 **DANGER**

**Do not attach an apron drainboard to a single fryer. The fryer may become unstable, tip over, and cause injury. The appliance area must be kept free and clear of combustible material at all times.**

2. Level fryers equipped with legs by screwing out the legs approximately 1 inch then adjusting them so that the fryer is level and at the proper height in the exhaust hood. Frymaster recommends that the minimum distance from the flue outlet to the bottom edge of the hood be 24 in. (600 mm) when the appliance consumes more than 120,000 BTU per hour.
3. Test the fryer electrical system:
  - a. Plug the fryer electrical cord(s) into a grounded electrical receptacle.
  - b. Place the computer switch in the **ON** position. Verify that the display indicates **MLT-CYCL**.
  - c. Place the computer power switch in the **OFF** position. Verify that the display indicates **OFF**.
4. Refer to the data plate on the inside of the fryer door to determine if the fryer burner is configured for the proper type of gas before connecting the fryer quick-disconnect device or piping from the gas supply line.





**DANGER**

**Fryers MUST be connected ONLY to the gas type identified on the attached rating plate.**

- Verify the minimum and maximum gas supply pressures for the type of gas to be used in accordance with the accompanying tables below.

Non- CE Standard for Incoming Gas Pressure		
	1814G	
Gas Type	Nat	LP
Min Pressure W.C/kpa/mbar	6/1.49/14.93	11/2.74/27.37
Max Pressure W.C/kpa/mbar	14.00/3.48/34.84	14.00/3.48/34.84

CE Standard for Incoming Gas Pressure				
	1814G			
Gas Type	G20	G25	G30	G31
Pressure (mbar) (1 mbar=10,2mm H <sub>2</sub> O)	20	20 or 25	28/30 or 50	37 or 50

Australia Standard for Incoming Gas Pressure		
	1814G	
Gas Type	Nat	LP
Min Pressure W.C/kpa/mbar	4.54/1.13/11.30	11.05/2.75/27.50
Max Pressure W.C/kpa/mbar	14.00/3.48/34.84	14.00/3.48/34.84

Korea Standard for Incoming Gas Pressure		
	1814G	
Gas Type	LNG (Natural)	LPG (Propane)
Min Pressure W.C/kpa/mbar	4/1.00/10.00	9.2/2.30/23.00
Max Pressure W.C/kpa/mbar	10/2.50/25.00	13.2/3.30/33.00



**DANGER**

**When pressure-testing incoming gas supply lines, disconnect the fryer from the gas line if the test pressure is ½" PSI [3.45 kPa (14 inches W.C.)] or greater to avoid damage to the fryer's gas piping and gas valve(s).**

**NOTE:** External gas regulators are not normally required on this fryer. A safety control valve protects the fryer against pressure fluctuations. If the incoming pressure is in excess of ½" PSI (3.45 kPa/35 mbar), **a step-down regulator is required.**

- For fryers equipped with a filter system or basket lifts, plug the electrical cord(s) into a power receptacle behind the fryer.

## 2.4 Connection to Gas Line



**DANGER**

**Before connecting new pipe to this appliance, the pipe must be blown out thoroughly to remove all foreign material. Foreign material in the burner and gas controls will cause improper and dangerous operation.**

**⚠ DANGER**

The appliance and its individual shutoff valve must be disconnected from the gas supply piping system during any pressure testing of the system at test pressures in excess of ½ PSI (3.45 kPa, 13.84 inches W.C.) to avoid damage to the fryer’s gas tubes and gas valve(s).

**⚠ DANGER**

The appliance must be isolated from the gas supply piping system by closing its individual manual shutoff valve during any pressure testing of the gas supply piping system at test pressures equal to or less than ½ PSI (3.45 kPa, 13.84 inches W.C.)

**⚠ DANGER**

“Dry-firing” your unit will cause damage to the frypot and can cause a fire. Always ensure that cooking oil or water is in the frypot before firing the unit.

**⚠ DANGER**

All connections must be sealed with a joint compound suitable for the gas being used and all connections must be tested with a solution of soapy water before lighting any pilots.

Never use matches, candles, or any other ignition source to check for leaks. If gas odors are detected, shut off the gas supply to the appliance at the main shut-off valve and immediately contact the local gas company or an authorized service agency for service.

The size of the gas line used for installation is very important. If the line is too small, the gas pressure at the burner manifold will be low. This may cause slow recovery and delayed ignition. The incoming gas supply line should be a minimum of 1½" (38 mm) in diameter. Refer to the chart below for the minimum sizes of connection piping.

<b>Gas Connection Pipe Sizes</b> (Minimum incoming pipe size should be 1 1/2" (41 mm))			
<b>Gas</b>	<b>Single Unit</b>	<b>2 - 3 Units</b>	<b>4 or more units*</b>
Natural	3/4" (22 mm)	1" (28 mm)	1 1/4" (36 mm)
Propane	1/2" (15 mm)	3/4" (22 mm)	1" (28 mm)
Manufactured	1" (28 mm)	1 1/4" (36 mm)	1 1/2" (41 mm)

\* For distances of more than 20 feet (6 m) and/or more than 4 fittings or elbows, increase the connection by one pipe size.

### 2.4.1 Gas Specifications

<b>NON-CE (Altitudes of 2000 feet or less)</b>							
<b>MODEL</b>	<b>INPUT (BTU)</b>	<b>GAS TYPE</b>	<b>ORIFICE (MM)</b>	<b>ORIFICE PART NO.</b>	<b>QTY</b>	<b>EQUIPMENT PRESSURE</b>	
						<b>MBAR</b>	<b>INCH W.C.</b>
1814	119000	NAT LP	2.26(#43)	810-2938	5	10	4
			1.40(#54)	810-2939	5	27.5	11

**NOTE:** Outlet gas pressure must be adjusted strictly within the above requirements 5 to 10 minutes after the appliance is operating. (Pilot Flame Adjustment: Turn the pilot adjustment screw clockwise/counter-clockwise until the desired flame-volume is achieved.)

<b>CE ONLY (Altitudes of 2000 feet or less)</b>							
MODEL	INPUT (kW)	GAS TYPE	ORIFICE (MM)	QTY	PILOT ORIFICE (MM)	EQUIPMENT PRESSURE	
						MBAR	INCH W.C.
1814	33,7	G20	2,2	5	.46	10,0	4,0
		G25	2,2	5	.46	15,0	6,0
		G31	1,4	5	.33	23,9	9,5

**NOTE:** Outlet gas pressure must be adjusted strictly within the above requirements 5 to 10 minutes after the appliance is operating. (Pilot Flame Adjustment: Turn the pilot adjustment screw clockwise/counter-clockwise until the desired flame-volume is achieved.)

The 1814 with FilterQuick™ Series gas fryer has received the CE mark for the countries and gas categories indicated in the table on the following page. **NOTE:** The nominal heat input (QN) is 21kW except for AT, DE, LU and category 3P/B, which is 23kW.

<b>CE Approved Gas Categories by Country</b>			
COUNTRIES	CATEGORIES	GAS	PRESSURE (MBAR)
AUSTRIA (AT)	I12H3B/P	G20	20
		G30, G31	50
BELGIUM (BE)	I2E(R)B	G20, G25	20, 25
	I3+	G30, G31	28-30, 37
DENMARK (DK)	I12H3B/P	G20	20
		G30, G31	30
FRANCE (FR)	I12Esi3+	G20, G25	20, 25
		G30, G31	28-30, 37
	I12Esi3P	G20, G25	20, 25
		G31	50
FINLAND (FI)	I12H3B/P	G20	20
		G30, G31	30
GERMANY (DE)	I12ELL3B/P	G20, G25	20
		G30, G31	50
GREECE (GR)	I12H3+	G31	50
		G20	20
ITALY (IT)	I12H3+	G30, G31	28-30, 37
		G20	20
IRELAND (IE)	I12H3+	G30, G31	28-30, 37
		G20	20
LUXEMBOURG (LU)	I12E3B/P	G30, G31	50
		G20	20
NETHERLANDS (NL)	I12L3P	G25	25
		G31	50
	I12L3B/P	G25	25
		G30, G31	30
NORWAY (NO)	I3B/P	G30, G31	30
		G20	20
PORTUGAL (PT)	I12H3+	G30, G31	28-30, 37
		G20	20
SPAIN (ES)	I12H3+	G30, G31	28-30, 37
		G20	20
	I12H3P	G20	20
		G31	37, 50
SWEDEN (SE)	I12H3B/P	G20	20
		G30, G31	30
UNITED KINGDOM (UK)	I12H3+	G20	20
		G30, G31	28-30, 37

**CE Standard**  
**Required airflow for the combustion air supply is 2m<sup>3</sup>/h per kW.**

1. Connect the quick-disconnect hose to the fryer quick-disconnect under the fryer and to the building gas line.

**NOTE:** Some fryers are configured for a rigid connection to the gas supply line. These units are connected to the gas supply line at the rear of the unit.

When using thread compound, use very small amounts on male threads only. Use a pipe thread compound that is not affected by the chemical action of LP gases (Loctite™ PST56765 Sealant is one such compound). DO NOT apply compound to the first two threads. Doing so may allow some of the compound to enter the gas stream, resulting in clogging of burner orifices and/or the control valve.

2. Open the gas supply to the fryer and check all piping, fittings, and gas connections for leaks. A soap solution should be used for this purpose.
3. Plug in the fryer to ensure the fryer drain valve is closed and fill the frypot with water or oil to the bottom OIL LEVEL line at the rear of the frypot. Light the fryer described in the “Lighting Instructions” topics found in Chapter 3 of this manual.

**⚠ DANGER**

**“Dry-firing” your unit will cause damage to the frypot and can cause a fire. Always ensure that cooking oil or water is in the frypot before firing your unit.**

4. The burner manifold pressure should be checked with a manometer at this time by the local gas company or an authorized service agent.
5. Check the rating plate for specific manifold gas pressures.
6. Confirm that the arrow forged into the bottom of the regulator body, which indicates gas flow direction, is pointed downstream towards the fryers. The air vent cap is also part of the regulator and should not be removed. If a vent line from the gas pressure regulator is used, it should be installed in accordance with local codes or in the absence of local codes, with the National Fuel Gas Code, ANSI Z223.1-(latest edition) in the U.S. and appropriate national or European harmonized standards (EN) in the European Union.
7. The tables list the burner manifold gas pressures for the various gas types that can be used with this equipment.

<b>Non-CE Standard Burner Manifold Gas Pressures</b>	
<b>Gas</b>	<b>Pressure</b>
Natural	3.20" W.C. 0.80 kPa
Propane	8.25" W.C. 2.5 kPa

<b>CE Standard Burner Manifold Gas Pressures</b>	
<b>Gas</b>	<b>Pressure (mbar)</b>
Natural Gas Lacq (G20) under 20 mbar	7
Natural Gas Gronique * (G25) under 25 mbar	10
Natural Gas Gronique (G25) under 20 mbar	10
Butane/Propane (G30) at 28/30 or 50 mbar	17
Propane (G31) under 37 or 50 mbar	20.6

\* Belgian G25 = 7,0 mbar

<b>AUSTRALIA ONLY Burner Manifold Gas Pressures</b>						
	<b>Natural Gas</b>			<b>Propane Gas</b>		
	<b>Orifice</b>	<b>MJ/h</b>	<b>TPP</b>	<b>Orifice</b>	<b>MJ/h</b>	<b>TPP</b>
<b>Full Vat</b>	2.92mm	73.8	1.0 kPa	1.95mm	73.8	2.05 kPa
<b>Split Vat</b>	2.84mm	36.9 each 73.8 total	1.0 kPa	1.95mm	36.9 each 73.8 total	2.05 kPa

 **WARNING**

**Use a leak detection fluid to find potentially dangerous gas leaks when making new connections.**

- A. Regulators can be adjusted in the field, but it is recommended that qualified service personnel adjust a regulator only if it is known to be out of adjustment or serious pressure fluctuations have been found and cannot be solved another way.
  - B. Only qualified service personnel should make adjustments to the regulators.
  - C. Orifices: The fryer can be configured to operate on any available gas. The correct safety control valve, appropriate gas orifices, and pilot burner are installed at the factory. While the valve can be adjusted in the field, only qualified service personnel should make adjustments with proper test equipment.
8. Check the programmed temperature thermostat setting. (Refer to chapter 1 FilterQuick™ Controller Manual) for the setpoint programming instructions for your particular controller.)

#### **2.4.2 Equipment Installed at High Altitudes**

- 1. The fryer input rating (BTU/hr) is for elevations up to 2,000 ft (610 m). For elevations above 2,000 ft (610m), the rating should be reduced four percent for each additional 1,000 ft (305m) above sea level.
- 2. The correct orifices are installed at the factory if operating altitude is known at time of the customer's order.

#### **2.5 Converting to another Gas Type**

 **DANGER**

**This appliance was configured at the factory for a specific type of gas. Converting from one type of gas to another requires the installation of specific gas-conversion components. Conversion instructions are included with conversion kits.**

**Switching to a different type of gas without installing the proper conversion components may result in fire or explosion. NEVER ATTACH THIS APPLIANCE TO A GAS SUPPLY FOR WHICH IT IS NOT CONFIGURED!**

**Conversion of this appliance from one type of gas to another should only be performed by qualified, licensed, and authorized installation or service personnel, as defined in Section 1.7 of this manual.**

**CE Gas Conversion Kits  
826-2937 — Natural to Propane  
826-2938 — Propane to Natural**

## CE GAS CONVERSION INSTRUCTIONS

1. Between G20- and G25-type Natural Gas, adjust the gas pressure at the regulator. (Refer to the CE Standard Burner Manifold Gas Pressure Chart.) Do not change the orifice.
2. Between a 2<sup>nd</sup> family (G20 or G25) and a 3<sup>rd</sup> family gas (G30 Butane or G31 Propane):
  - a. Change the orifices.
  - b. Adjust the manifold pressure.
3. Remove the old rating plate and return to Frymaster. Affix the new rating plate included with the conversion kit in place of the old rating plate stating the gas has been converted.
4. If the destination language changes, replace the rating plate. Call your local service agency or KES for a label kit. The language of reference will be on the corner of the label.

**Conversions can only be executed by qualified, factory-authorized personnel.**



Typical non-CE gas valve for electronic-ignition equipped fryers.

### 2.6 Positioning the Fryer

1. Once the fryer has been positioned at the frying station, use a carpenter's level placed across the top of the frypot to verify that the unit is level, both side-to-side and front-to-back.

To level fryers, adjust the casters being careful to ensure the fryer(s) are at the proper height in the frying station.

When the fryer is leveled in its final position, install the restraints provided by the KES to limit its movement so that it does not depend on or transmit stress to the connection. Install the restraints in accordance with the provided instructions. If the restraints are disconnected for service or other reasons, they must be reconnected before the fryer is used.

### DANGER

**Hot oil can cause severe burns. Avoid contact. Under all circumstances, oil must be removed from the fryer before attempting to move it to avoid spills, falls, and severe burns. Fryers may tip and cause personal injury if not secured in a stationary position.**

**⚠ DANGER**

**Adequate means must be provided to limit the movement of this appliance without depending on the connector and the quick-disconnect device or its associated piping to limit the appliance movement.**

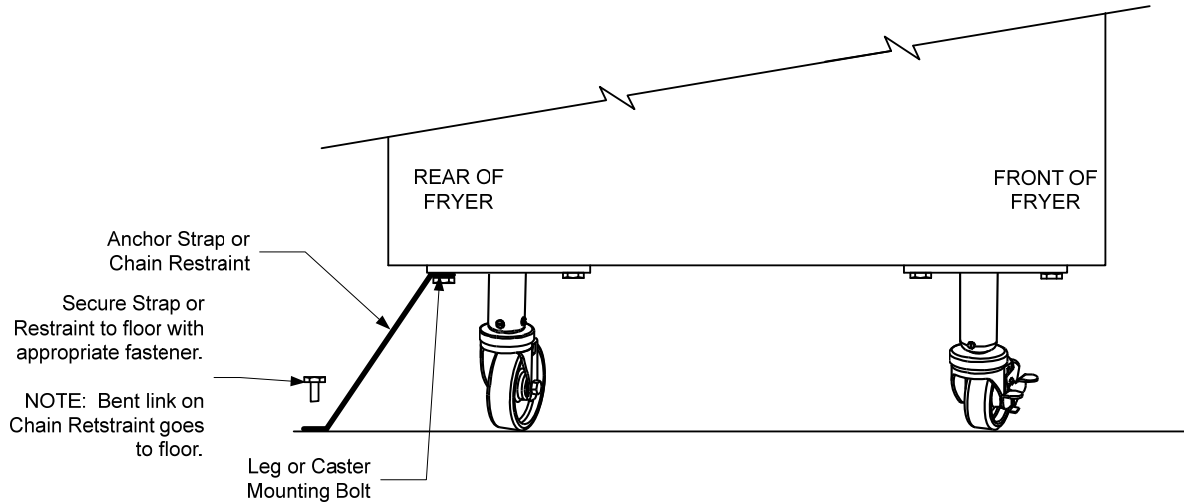

2. Close fryer drain-valve(s).
3. Clean and fill frypot(s) to the bottom oil level line with cooking oil. (See **Equipment Setup and Shutdown Procedures** in Chapter 3.)

## 2.7 Installing the Oil Saddle Reservoir

Carefully cut the shipping strap around the oil saddle hose on the rear of the fryer. Attach the hose to the oil saddle reservoir quick disconnect on the bottom of the reservoir. Lift up the orange quick disconnect and insert the male adaptor of the hose. Once the male end is fully inserted, release the quick disconnect to attach. Once attached, pull gently on the hose to ensure it is connected (see Figure 1).

Using the enclosed strap, attach to the saddle hose as shown. Attach to the oil saddle handle to keep the hose off of the floor (see Figure 2).



**Figure 2**



**Figure 1**

# 1814G with FILTERQUICK™ SERIES GAS FRYER

## CHAPTER 3: OPERATING INSTRUCTIONS

---

### FINDING YOUR WAY AROUND THE 1814G with FILTERQUICK™ SERIES GAS FRYER

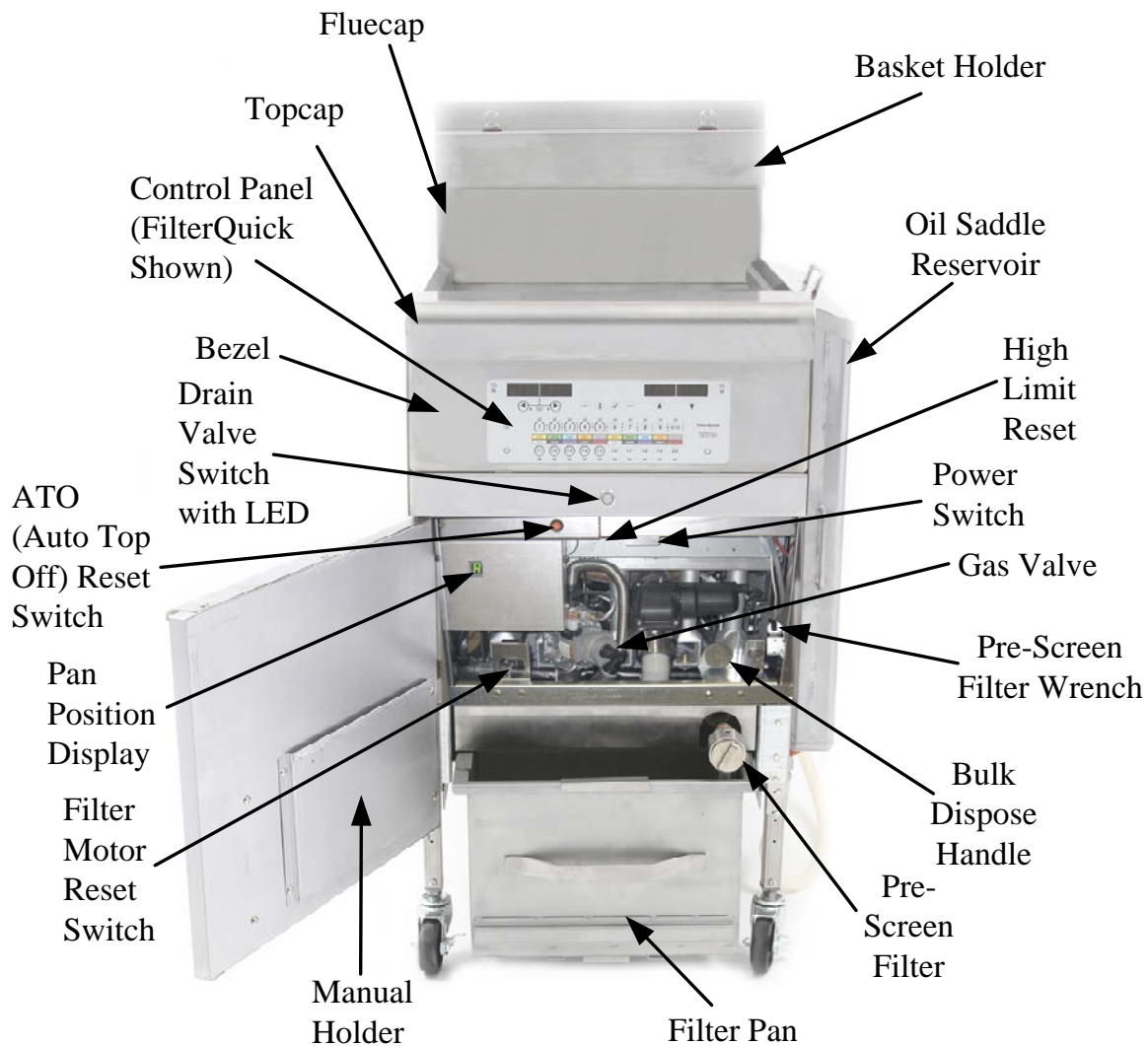

#### TYPICAL CONFIGURATION (11814G with FILTERQUICK™ GAS SHOWN)

**NOTE:** The appearance of your fryer may differ slightly from that shown depending upon configuration and date of manufacture.



### 3.1 Controller Operation and Programming

This fryer is equipped with the FilterQuick™ controller (illustrated below). Fryers with FilterQuick™ controllers should refer to the *FilterQuick™ Controller Manual 8197206* for the controller programming and operating procedure.



**FILTERQUICK™ CONTROLLER**

Refer to Chapter 4 of this manual for operating instructions for the built-in filtration system.

### 3.2 Equipment Setup and Start-Up Procedures

#### **⚠ WARNING**

The on-site supervisor is responsible for ensuring that operators are made aware of the inherent hazards of operating a hot oil filtering system, particularly the aspects of oil filtration, draining and cleaning procedures.

#### **⚠ CAUTION**

The 1814G with FilterQuick™ is not intended to use solid shortening without a solid shortening kit installed. Use only liquid shortening with this fryer if a solid shortening kit is not installed. The use of solid shortening without a solid shortening kit will clog the oil lines. The oil capacity of the 1814G with FilterQuick™ fryer is 60 lbs. (7.93 gallons/30 liters) at 70°F (21°C).

Before lighting the fryer, make sure the fryer is OFF and the frypot drain valve(s) is/are closed. Remove the basket support rack(s), if installed, and fill the frypot to the bottom OIL-LEVEL line.

#### 3.2.1 Setup

#### **⚠ WARNING**

Never operate this appliance with an empty frypot. The frypot must be filled with water or oil before lighting the burners. Failure to do so will damage the frypot and may cause a fire.

#### **⚠ DANGER**

Remove all drops of water from the frypot before filling with oil. Failure to do so will cause spattering of hot liquid when the oil is heated to cooking temperature.

1. Fill the frypot with cooking oil to the bottom OIL LEVEL line located on the rear of the frypot (see photo on the following page). This will allow for oil expansion as heat is applied. Do not fill cold oil any higher than the bottom line; overflow may occur as heat expands the oil. For

bulk oil systems see Section 1.9.8 in the *FilterQuick™ Controller Manual 8197206* for instructions to fill the vat from bulk. If using solid shortening, cut it into small pieces and pack it below the heat tubes, between the tubes and on top of the tubes, leaving no air spaces around the tubes. Do not disturb or bend the probe sensing bulbs.

**Top (Hot) OIL LEVEL line**

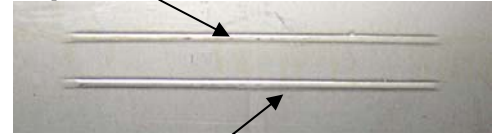

**Bottom (Cold) OIL LEVEL line**

2. Ensure that the power cord(s) are plugged into the appropriate receptacle(s). Verify that the face of the plug is flush with the outlet plate, with no portion of the prongs visible.
3. Ensure that the power is switched on with the master switch, located behind the fryer door under the control box.

### 3.2.2 Lighting the Fryer

1. Ensure the controller is in the OFF position.
2. Ensure the gas is "ON".

#### For CE Fryers

Placing the ON/OFF switch on the controller in the OFF position also turns off the gas valve. Wait five minutes before continuing with Step 3, which will also turn on the gas valve. **NOTE:** There is not a physical ON/OFF knob on CE gas valves.

#### For Non-CE Fryers

After placing the ON/OFF switch on the controller in the OFF position, turn the gas valve knob to the OFF position. Wait 5 minutes, then turn the knob to the ON position and proceed with Step 3.

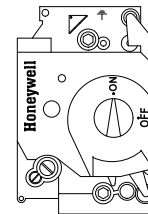
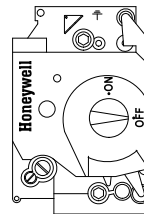

3. Ensure that the controller is switched **ON** by pressing the ON/OFF switch  to the **ON** position.

#### **WARNING**

**Never use a match or taper to light pilot on this ignition system.**

4. The ignition module will energize the pilot gas supply and the ignitor. The ignitor spark will ignite the pilot gas. The presence of the pilot flame is then proved by a flame sensor, which sends a signal to the main gas supply, opening the valve. The controller controls the fryer after ignition.

All Frymaster fryers are tested, adjusted and calibrated to sea level conditions before leaving the factory. Adjustments to assure proper operation of pilot may be necessary on installation to meet local conditions, low gas pressure, differences in altitude and variations in gas characteristics. These adjustments correct possible problems caused by rough handling or vibration during shipment, and are to be performed only by qualified service personnel. These adjustments are the responsibility of the customer and/or the dealer and are not covered by the Frymaster warranty.



**Pilot in normal operation.**

The inlet pipe at the lower rear of the fryer brings incoming gas to the pilot safety control valve, then to the pilot and main burners. The pilot is located high in the cabinet center, at the base of the frypot.

 **WARNING**

**In the event of prolonged power failure, the ignition module will shut down and lock out the system. Turn the controller to "OFF" and then back "ON" after power has been re-established.**

5. If the pilot flame fails, the ignition module will shut down and lock out the system. To restart, turn the controller "OFF", wait approximately 5 minutes for the system to recycle itself, then repeat step 3.

 **CAUTION**

**If the pilot and main burner go out, the fryer(s) MUST be left completely shut down at least 5 minutes before lighting.**

 **WARNING**

**When checking for burner ignition or performance, do not get too close to the burners. Slow ignition can cause possible flashback, increasing the potential for facial and body burns.**

6. When the controller is switched on, if the fryer temperature is below 180°F (82°C) the fryer will begin heating and will display *MELT-CYCLE* alternating with the fryer temperature until the fryer reaches 180°F (82°C)(**NOTE:** During the melt cycle, the burners will repeatedly fire for a few seconds, then go out for a longer period.) The fryer temperature is displayed until within 10°F of setpoint when the controller displays -----. Once the fryer reaches setpoint, the controller displays **READY** and the fryer is ready for use. To exit the melt cycle, press the COOL button. Answer **YES** to **EXIT MELT?** If solid shortening is used, the MELT cycle **MUST** be used to melt the shortening. **DO NOT DISABLE OR CANCEL THE MELT CYCLE IF USING SOLID SHORTENING.**
7. Ensure that the oil level is at the *top* OIL LEVEL line when the oil *is at its cooking temperature*. Auto top off will ensure the oil level is maintained at the top OIL LEVEL line.

### **3.3 Shutting the Fryer Down**

For short-term shut down during the workday, place the controller ON/OFF switch in the **OFF** position and put the frypot covers in place (if the fryer is so equipped).

When shutting the fryers down at closing time, filter the oil and clean the fryers. Place the controller ON/OFF switch in the **OFF** position. Then place the gas valve in the off position. See illustration on the following page. Place the frypot covers on the frypots.

### For CE Fryers

Placing the ON/OFF switch on the controller in the OFF position also turns off the gas valve. NOTE: There is not a physical ON/OFF knob on CE gas valves.

### For Non-CE Fryers

After placing the ON/OFF switch on the controller in the OFF position, turn the gas valve knob to the OFF position.

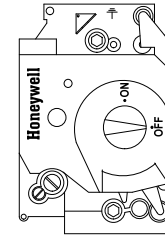
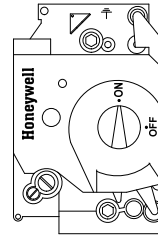

## 3.4 Oil Attendant® Automatic Top-Off

When the Oil Attendant® top-off oil system is in place on the fryer, oil is continually topped off in the frypots from the saddle oil reservoir attached to the cabinet. The reservoir holds a 35 pound box of oil. In a typical operation this will last approximately two days before changing. Components of the system are annotated at the right and below (see Figure 1).

NOTE: The top off system is intended to top off the frypots, not fill them. The frypots will require manual filling upon startup and after disposal.

### ATO Reset Switch:

Resets the ATO system after oil change.

**Saddle Reservoir:** Has plumbing attached to draw oil from the reservoir to the fryer vats.

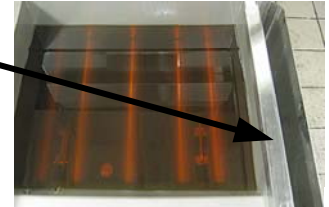
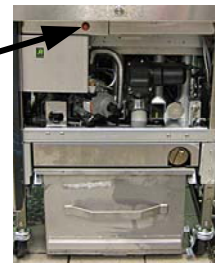

Figure 1

### 3.4.1 Adding Oil to the Oil Saddle Reservoir

Remove the Oil Saddle Reservoir lid (see Figure 2) and fill with oil. Once the reservoir is full ensure the lid is placed over the reservoir. Ensure the quick disconnect fitting with hose is fully seated to the fitting on the bottom of the oil saddle.

The system is now ready for operation. As the fryer heats to preprogrammed temperatures, the system will energize and then slowly add oil to the frypot as needed, until the oil reaches an optimal level.



Figure 2

### WARNING:

**Do not add HOT or USED oil to the Oil Saddle Reservoir.**

### 3.4.2 Routine Oil Changes

When the oil reservoir level is low, the controller displays **TOPOFF OIL EMPTY** in the left display and **YES NO** in the right display. Press ▲ (**YES**) and follow the prompts.

1. Remove saddle oil reservoir lid (see Figure 2 in section 3.4.1).
2. Fill the oil saddle with oil.
3. Replace saddle oil reservoir lid.
4. Press and hold the orange ATO reset switch five (5) seconds to reset the top off system (see Figure 3).

The system is now ready for operation. As the fryer heats to preprogrammed temperatures, the system will energize and then slowly add oil to the frypot as needed, until the oil reaches an optimal level.

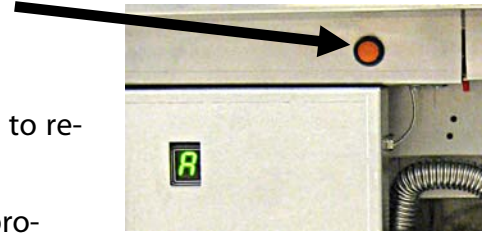

Figure 3

### 3.4.3 Bulk Oil Systems

**Instructions for installing and using bulk oil systems are found in Appendix A located at the rear of this manual.**

# 1814G with FILTERQUICK™ SERIES GAS FRYERS

## CHAPTER 4: FILTRATION INSTRUCTIONS

### 4.1 Introduction

The 1814G with FilterQuick™ with fingertip filtration system allows the oil in one frypot to be safely and efficiently filtered while the other frypots in a battery remain in operation.

Section 4.2 covers preparation of the filter system for use. Operation of the system is covered in Section 4.3.

#### **⚠ WARNING**

**The on-site supervisor is responsible for ensuring that operators are made aware of the inherent hazards of operating a hot oil filtering system, particularly the aspects of oil filtration, draining and cleaning procedures.**

#### **⚠ WARNING**

**The filter pad or paper MUST be replaced daily or when the sediment level exceeds the height of the hold down ring.**

### 4.2 Preparing the 1814G with FilterQuick™ with Fingertip Filtration System for Use with Filter Paper or Filter Pad

The 1814G with FilterQuick™ with fingertip filtration system allows the oil in one frypot to be safely and efficiently filtered while the other frypots in a battery remain in operation. The 1814G with FilterQuick™ filtration system uses a filter paper configuration which includes a crumb tray, large hold-down ring, and metal filter screen.

1. Pull the filter pan out from the cabinet and remove the crumb tray, hold-down ring, filter paper and filter screen (see Figure 1). Clean all components with a solution of detergent and hot water then dry thoroughly.

Disposal instructions are in the controller manual 8197206.

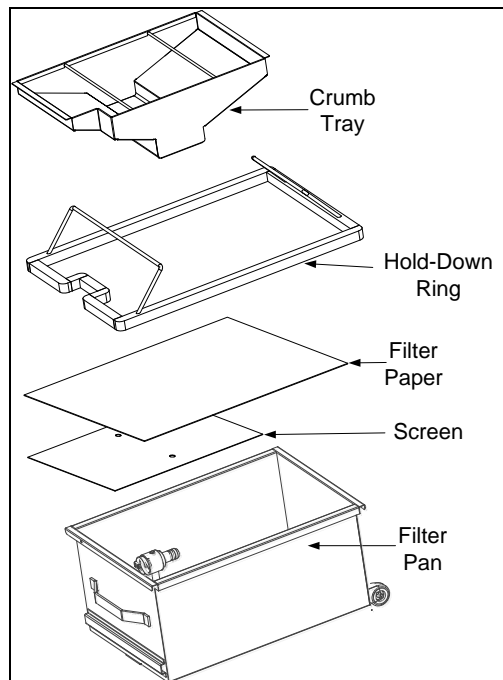

Figure 1

2. Inspect the filter pan connection fitting to ensure that both O-rings are in good condition (see Figure 2).
3. Then in reverse order, place the metal filter screen in the center of the bottom of the pan, then lay a sheet of filter paper on top of the screen, overlapping on all sides (see Figure1). If using a filter pad, ensure the rough side of the pad is up and lay the pad over the screen, making sure that the pad is in between the embossed ridges of the filter pan.
4. Position the hold-down ring over the filter paper and lower the ring into the pan, allowing the paper to rest on the sides of the filter pan (see Figure 3).
5. When the hold-down ring is in position, if using filter paper, sprinkle one packet of filter powder evenly over the paper (see Figure 4).

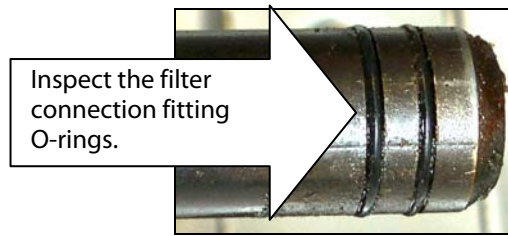

Figure 2



Figure 3

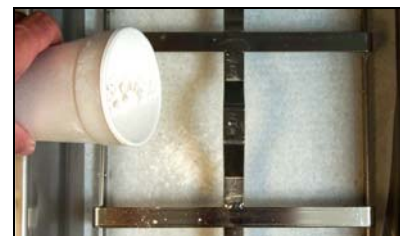

Figure 4

**DO NOT USE FILTER POWDER WITH THE PAD!**

6. Replace the crumb tray in the filter pan, then push the filter pan back into the fryer, positioning it under the drain.
7. Push the filter pan back into the fryer, positioning it under the fryer. Ensure "A" is displayed on the MIB board. The filtration system is now ready for use.

**⚠ DANGER**

**Do not drain more than one frypot at a time into the built-in filtration unit to avoid overflow and spillage of hot oil that may cause severe burns, slipping and falling.**

**⚠ DANGER**

**The crumb tray in fryers equipped with a filter system must be emptied into a fireproof container at the end of frying operations each day. Some food particles can spontaneously combust if left soaking in certain shortening material.**

**⚠ WARNING**

**Do not bang fry baskets or other utensils on the fryer's joiner strip. The strip is present to seal the joint between the fry vessels. Banging fry baskets on the strip to dislodge shortening will distort the strip, adversely affecting its fit. It is designed for a tight fit and should only be removed for cleaning.**

**4.3 1814G with FilterQuick™ with Fingertip Filtration**

The FilterQuick™ controller has a feature that will prompt the operator to begin the semi-automatic filtration process, after a number of preset cook cycles.

A FilterQuick™ controller controls the semi-automatic filtration system on the 1814G with FilterQuick™ fryer. After a preset number of cook cycles the controller displays **FILTER NOW?** alternating with **YES NO**. If **NO** is selected or a cook cycle is started, the controller will resume normal operation for a set amount of cooks and then prompt for a filter again. The FILTER NOW? prompt is displayed once the cooks till filter or filter prompt count is satisfied. Refer to the FilterQuick™ controller manual for filter steps. All messages need to be confirmed or cleared on all controllers prior to starting any filtration process.

#### 4.4 Troubleshooting the 1814G with FilterQuick™ with Fingertip Filtration

##### 4.4.1 Incomplete Filtration

Should the filter procedure fail after the filter paper or pad was changed an error message is generated.

The controller displays **IS VAT FULL?** alternating with **YES NO**.  
The MIB board displays three horizontal lines.

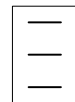

1. If the vat is full press the **▲ (YES)** button to continue. The controller returns to idle cook mode or OFF.

If the pot is not filled completely continue to next step.

2. Press **▼ (NO)** if pot is not filled completely.

The controller displays **FILLING** while the pump runs again. When the pump stops, the controller displays **IS VAT FULL?** alternating with **YES NO** again. If the vat is full go to step 1. If the vat is not completely filled continue.

3. Press **▼ (NO)** if pot is not filled completely.

The controller displays **FILLING** while the pump runs again. When the pump stops, the controller displays **IS VAT FULL?** alternating with **YES NO** again. If the vat is full go to step 1. If the vat is not completely filled continue.

4. Press **▼ (NO)** if pot is not filled completely. If this is the sixth consecutive sequence of incomplete filtration skip to step 8.

The controller displays **CHANGE FILTER PAPER?** alternating with **YES NO** and an alarm.

5. Press **▲ (YES)** to continue.

Pressing **▼ (NO)** allows the fryer to return to cook mode in most cases for four minutes or 15 minutes if the paper is expired\*, ending with the **CHANGE FILTER PAPER?** alternating with **YES NO** display.



This repeats until **YES** is chosen.

The controller displays **REMOVE PAN**.

\***NOTE:** If the filter paper change time has expired, normally every 25 hours, the **CHANGE FILTER PAPER?** message repeats every 15 minutes instead of every four minutes.

6. Remove the pan. The controller display changes to **CHANGE PAPER**. Change the filter paper and ensure the filter pan has been pulled forward, out of the cabinet for at least 30 seconds. Once the pan has been out for 30 seconds the controller displays **OFF**. Ensure the pan is completely dry with no water or moisture and assembled correctly. Push the filter pan back into the fryer. Ensure "**A**" is displayed on the MIB board.
7. Switch the controller on. The controller displays the fryer temperature until the fryer reaches setpoint.
8. If a filtration error occurs six consecutive times, the return valve closes and the controller displays **SERVICE REQUIRED** alternating with **YES** and an alarm.
9. Press **▲ (YES)** to silence alarm and continue.

The controller displays **SYSTEM ERROR** and the error message for 15 seconds changing to **SYSTEM ERROR FIXED** alternating with **YES NO**.

10. Press **▼ (NO)** to continue cooking. Call your FAS to repair and reset the fryer. The error will be re-displayed every 15 minutes until the issue is repaired. Semi-automatic filtration and auto top off is disabled until the fryer is reset.

#### 4.5 Filter Busy

When **FILTER BUSY** is displayed on the controller, the system is waiting on another vat to be filtered or waiting on another issue to clear. Wait 15 minutes to see if problem is corrected. If not, call your local FAS.

#### **DANGER**

**Do not drain more than one frypot at a time into the built-in filtration unit to avoid overflow and spillage of hot oil that may cause severe burns, slipping and falling.**

#### **WARNING**

**The filter pump is equipped with a manual reset switch in case the filter motor overheats or an electrical fault occurs. If this switch trips, turn off power to the filter system and allow the pump motor to cool 20 minutes before attempting to reset the switch (see photo on the next page).**

**⚠ WARNING**

**Use caution and wear appropriate safety equipment when resetting the filter pump reset switch. Resetting the switch must be accomplished with care to avoid the possibility of a serious burn from careless maneuvering around the drain tube and frypot.**



**Filter Pump Reset Switch**

#### **4.6 Draining and Refilling Vats, and Disposing of Oil**

When cooking oil requires changing, drain the oil into an appropriate container for transport to the disposal container. (For safe, convenient draining and disposal of used oil, Frymaster recommends the use of the Frymaster Shortening Disposal Unit (SDU). The SDU is available through your local distributor.) **Do not drain boil-out solution into an SDU. NOTE:** Only an SDU built after January 2004 will fit beneath the drain. If a shortening disposal unit is not available, allow the oil to cool to 100°F (38°C), then drain the oil into a **METAL** container with a capacity of EIGHT (8) gallons (30 liters) or larger to prevent oil from spilling. If using a bulk oil system, follow the disposal and refilling instructions for bulk oil in the FilterQuick Controller Manual 8197206.

**⚠ DANGER**

**When draining oil into an appropriate METAL container, make sure the container will hold at least EIGHT gallons (30 liters) or more, otherwise hot liquid could overflow and cause injury.**

**⚠ DANGER**

**Allow oil to cool to 100°F (38°C) before draining into an appropriate METAL container for disposal.**

**⚠ DANGER**

**When draining oil into a disposal unit, do not fill above the maximum fill line located on the container.**

**⚠ DANGER**

**Draining and filtering of cooking oil must be accomplished with care to avoid the possibility of a serious burn caused by careless handling. The oil to be filtered is at or near 350°F (177°C). Wear all appropriate safety equipment when draining and filtering oil.**

**⚠ WARNING**

**NEVER drain boil-out solution into an SDU. Boil-out solution can cause damage to an SDU.**

1. Turn the controller power switch to the **OFF** position.
2. Remove the filter pan and position the SDU or METAL container with a sealable cover with a capacity of EIGHT gallons (30 liters) or larger under the fryer drainpipe to drain the oil. The METAL container must be able to withstand the heat of the oil and hold hot liquids.
3. Follow the instructions for disposing of oil in the FilterQuick™ controller manual for disposal or draining steps. If the drain valve becomes clogged with food particles, use the Fryer's Friend (poker-like tool) that was provided with the fryer, to clear the blockage.

**⚠ DANGER**

**DO NOT hammer on the drain valve with the cleanout rod or other objects. Damage to the ball inside will result in leaks and will void the Frymaster warranty.**

4. After draining the oil, clean all food particles and residual oil from the frypot. BE CAREFUL, this material may still cause severe burns if it comes in contact with bare skin.
5. Once the drain valve is closed, fill the frypot with clean, filtered or fresh cooking oil to the bottom OIL-LEVEL line.

# 1814G with FILTERQUICK™ SERIES ELECTRIC FRYER

## CHAPTER 5: PREVENTATIVE MAINTENANCE

---

### 5.1 Cleaning the Fryer

 **DANGER**

The crumb tray in fryers equipped with a filter system must be emptied into a fireproof container at the end of frying operations each day. Some food particles can spontaneously combust if left soaking in certain shortening material.

 **DANGER**

Never attempt to clean the fryer during the frying process or when the frypot is filled with hot oil. If water comes in contact with oil heated to frying temperature, it will cause spattering of the oil, which can result in severe burns to nearby personnel.

 **WARNING**

Use a commercial-grade cleaner formulated to effectively clean and sanitize food-contact surfaces. Read the directions for use and precautionary statements before use. Particular attention must be paid to the concentration of cleaner and the length of time the cleaner remains on the food-contact surfaces.

### 5.2 DAILY CHECKS AND SERVICE

#### 5.2.1 Inspect Fryer and Accessories for Damage- Daily

Look for loose or frayed wires and cords, leaks, foreign material in frypot or inside cabinet, and any other indications that the fryer and accessories are not ready and safe for operation.

#### 5.2.2 Clean Inside and Outside of the Fryer Cabinet – Daily

Clean inside the fryer cabinet with a dry, clean cloth. Wipe all accessible metal surfaces and components to remove accumulated oil and dust.

Clean outside the fryer cabinet with a clean, damp cloth soaked with detergent. Wipe with a clean, damp cloth.

#### 5.2.3 Clean the FilterQuick™ Filtration System Daily

 **WARNING**

**Never operate the filter system without oil in the system.**

 **WARNING**

**Never use the filter pan to transport old oil to the disposal area.**

 **WARNING**

**Never drain water into the filter pan. Water will damage the filter pump.**

Daily clean the filter pan and associated components with a solution of hot water and detergent.

If you notice that the system is pumping slowly or not at all, verify that the filter pan screen is on the bottom of the filter pan, with the paper on top of the screen. Verify that the two O-ring(s) on the fitting at the right front of the filter pan are present and in good condition. Remove and clean the pre-screen filter.

#### 5.2.4 Clean Filter Pan, Detachable Parts and Accessories

Carbonized oil will accumulate on the filter pan and detachable parts and accessories such as baskets, sediment trays, or fish plates.

Wipe the filter pan and all detachable parts and accessories with a clean cloth dampened with a detergent solution (or the parts can be run through a dishwasher). Rinse and thoroughly dry each part. DO NOT use steel wool or abrasive pads to clean these parts. The scratches that result from such scrubbing make subsequent cleanings more difficult.

#### 5.2.5 Clean Oil Level Float Switch

1. Drain the oil using the drain to pan option in the filter menu.
2. Use a no-scratch pad to clean carbonized oil, crumbs and sediment off of the float switch (see photo right).
3. Return the oil using the fill vat from pan option in the filter menu.



### 5.3 WEEKLY CHECKS AND SERVICE

#### 5.3.1 Drain and Clean Frypot

**⚠ DANGER**

**Never operate the appliance with an empty frypot. The frypot must be filled to the fill line with water or oil before lighting the burners. Failure to do so will damage the frypot and may cause a fire.**

After the fryer has been in use for a period of time, a hard film of caramelized oil will form on the inside of the frypot. This deposit must be periodically removed to maintain your fryer's efficiency. See the Clean and Filter procedure instructions in the FilterQuick™ controller manual to clean the frypot.

**⚠ DANGER**

**Allow oil to cool to 100°F (38°C) or lower before draining to an appropriate container for disposal.**

#### 5.3.2 Cleaning the Frypot using a Hot Clean (Boil Out) or Cold Clean (Cold Soak)

During normal usage of your fryer, a deposit of carbonized oil will gradually form on the inside of the frypot. This film should be periodically removed by following the Hot Clean (Boil-Out) or Cold Clean (Cold Soak) procedure. Use the instructions in the FilterQuick™ controller manual to clean the frypot.

**⚠ WARNING**

**To prevent injury, ensure adjacent vats that contain oil are OFF and covered prior to performing a Hot Clean (Boil Out) or Cold Clean (Cold Soak).**

To clean all frypots simultaneously, dispose of all the oil using the instructions in the FilterQuick™ controller manual. Once the oil is disposed follow the procedures below:

1. Program a product button for 195°F (91°C) and follow the instructions on the detergent container.
2. When the solution is finished simmering, turn off controller.
3. Remove the filter pan and position a METAL container with a sealable cover with a capacity of EIGHT gallons (30 liters) or larger under the fryer drainpipe to drain the boil out solution. The METAL container must be able to withstand the heat of the hot liquids.
4. Drain out the solution using the drain to pan instructions in the FilterQuick™ controller manual and clean the frypot(s) thoroughly.

**⚠ WARNING**

**Never allow water to boil down and expose the heating tubes. Frypot damage will result.**

**⚠ WARNING**

**Never leave the fryer unattended during this process. If the solution overflows, press the ON/OFF switch to the OFF position immediately.**

**⚠ WARNING**

**NEVER drain boil out or cleaning solution into a shortening disposal unit (SDU), a built-in filtration unit, a portable filter unit, or an OQS (Oil Quality Sensor). These units are not intended for this purpose, and will be damaged by the solution and void the warranty.**

**⚠ DANGER**

**When draining cleaning solution into an appropriate METAL container, make sure the container will hold at least EIGHT gallons (30 liters) or more, otherwise hot/cold liquid could overflow and cause injury.**

5. Refill the frypot(s) with clean water. Rinse the frypot(s) twice, drain and dry with a clean towel. Thoroughly remove all water from the frypot and burners before refilling the frypot with oil to the bottom OIL-LEVEL line.
6. Ensure the FilterQuick controller is reset to proper set temperature for cooking or the fryer will remain at 195°F (91°C) temperature.

**⚠ DANGER**

**Ensure that the frypot is completely free of water before filling with oil. When the oil is heated to cooking temperature, water in the frypot will cause splattering.**

### 5.3.3 Cleaning the Oil Saddle Reservoir

During normal usage of your fryer, a deposit of carbonized oil will gradually form on the inside of the oil saddle reservoir. It is recommended that the oil saddle be cleaned out according to the store's standard operating procedures. In lieu of standard operating procedures the oil saddle should be cleaned at the completion of a frypot boil out or cold soak when oxidized oil has started to adhere to and accumulate on the inner sides of the saddle. Clean outside the oil saddle reservoir with a clean, damp cloth soaked with detergent. Wipe with a clean, damp cloth. Follow the procedure below to clean the inside of the oil saddle reservoir.

1. Disconnect the quick disconnect on the bottom of the oil saddle reservoir.
2. Pour the saddle oil into the clean empty frypot.
3. Take the saddle to the sink.
4. Fill with wash temperature water and add a dish detergent cleaning agent. Use the provided nylon brush to scrub the residue from the sides and bottom of the saddle.
5. Flush with water until all detergent residue is removed.
6. Dry thoroughly before remounting to the frypot.
7. Reconnect the quick disconnect.
8. Fill with oil.

## 5.4 MONTHLY CHECKS AND SERVICE

### 5.4.1 Check FilterQuick™ Controller Set Point Accuracy

1. Insert a good-grade thermometer or pyrometer probe into the oil, with the end touching the fryer temperature-sensing probe.
2. When the controller displays READY (indicating that the frypot contents are within the cooking range), press the temperature button once to display the temperature of the oil as sensed by the temperature probe and the setpoint. The setpoint is denoted by the temperature with the degree symbol.
3. Note the temperature on the thermometer or pyrometer. Actual temperature and pyrometer readings should be within  $\pm 5^{\circ}\text{F}$  ( $3^{\circ}\text{C}$ ) of each other. If not, contact a Factory Authorized Servicer for assistance.

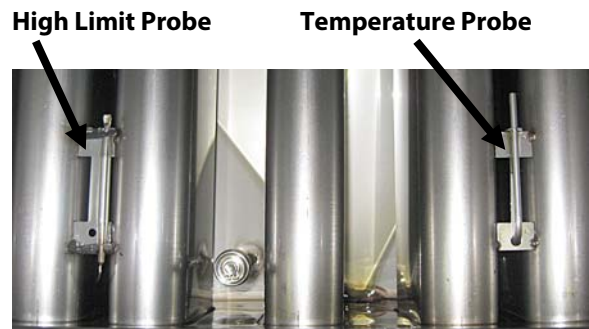

### 5.4.2 Pre-filter Maintenance

The pre-filter requires regular maintenance. Every 30 days, or more frequently if the flow of oil slows, remove the cap and clean the attached screen.

1. Wearing protective gloves use the supplied wrench to remove the cap from the pre-filter (**Figure 1**).
2. Use a small brush to clear debris from the attached screen (**Figure 2**).
3. Clean under a water tap and thoroughly dry.
4. Return the cap to the pre-filter housing and tighten.



Figure 1

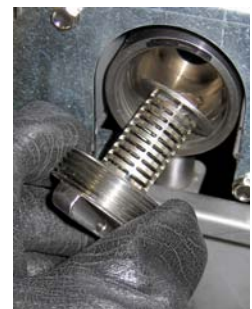

Figure 2



### **WARNING**

**DO NOT** remove the pre-filter cap when a filter cycle is under way.  
**DO NOT** operate the filter system with the cap removed. Wear protective gloves when handling the cap. The metal and the exposed oil are hot.

## **5.5 QUARTERLY CHECKS AND SERVICE**

### **5.5.1 Replace the O-rings**

Refer to page 4-2 for inspection of O-rings.

## **5.6 SEMI-ANNUAL CHECKS AND SERVICE**

### **5.6.1 Clean Gas Valve Vent Tube**

**NOTE: This procedure is not required for fryers configured for export to CE countries.**

1. Set the fryer power switch and the gas valve to the OFF position.
2. Carefully unscrew the vent tube from the gas valve. **NOTE:** The vent tube may be straightened for ease in removal.
3. Pass a piece of ordinary binding wire through the tube to remove any obstruction.
4. Remove the wire and blow through the tube to ensure it is clear.
5. Reinstall the tube and bend it so that the opening is pointing downward.

### **5.6.2 Check Burner Manifold Pressure**



### **DANGER**

**This task should be performed by qualified service personnel only. Contact your FAS to arrange this service.**

## **5.7 ANNUAL/PERIODIC SYSTEM INSPECTION**

**This appliance should be inspected and adjusted periodically by qualified service personnel as part of a regular kitchen maintenance program.**

**Frymaster recommends that this appliance be inspected at least annually by a Factory Authorized Servicer as follows:**

### **5.7.1 Fryer**

- Inspect the cabinet inside and out, front and rear for excess oil.
- Verify that debris or accumulations of solidified oil do not obstruct the flue opening.



- Verify that burners and associated components (i.e. gas valves, pilot assemblies, ignitors, etc.) are in good condition and functioning properly. Inspect all gas connections for leaks and verify that all connections are properly tightened.
- Verify that the burner manifold pressure is in accordance with that specified on the appliance's rating plate.
- Verify that the temperature and high-limit probes are properly connected, straight, tightened, secure and functioning properly, and that mounting hardware and probe guards are present and properly installed.
- Verify that component box components (i.e. controller, transformers, relays, interface boards, etc.) are in good condition and free from oil and other debris. Inspect the component box wiring and verify that connections are tight and that wiring is in good condition.
- Verify that all safety features (i.e. reset switches, etc.) are present and functioning properly.
- Verify that the frypot is in good condition and free of leaks. Verify that frypot tube diffusers are present and in good condition (i.e. no visible deterioration or damage).
- Verify that wiring harnesses and connections are tight and in good condition.

### **5.7.2 1814G with FilterQuick™ Filtration System**

- Inspect all oil-return and drain lines for leaks and verify that all connections are tight.
- Inspect the filter pan for leaks and cleanliness. If there is a large accumulation of crumbs in the crumb basket, advise the owner/operator that the crumb basket should be emptied into a fireproof container and cleaned daily.
- Verify that all O-rings and seals (including those on the quick-disconnect fittings) are present and in good condition. Replace O-rings and seals if worn or damaged.
- Check filtration system integrity as follows:
  - Verify that filter pan cover is present and properly installed.
  - With the filter pan empty, place each vat into fill vat from pan selection (see section 1.9.7 of the FilterQuick™ Controller Manual), one at a time. Verify proper functioning of each oil return valve by activating the filter pump using the fill vat from pan selection. Verify that the pump activates and that bubbles appear in the cooking oil of the associated frypot only.
  - Verify that the filter pan is properly prepared for filtering, then drain a frypot of oil heated to a setpoint above 300°F (149°C) (into the filter pan by using the drain to pan selection (see the FilterQuick™ Controller Manual). Now using the fill vat from pan drain pan selection (see the FilterQuick™ Controller Manual), allow all oil to return to the frypot (indicated by bubbles in the cooking oil). Press the up arrow button when all oil is returned. The frypot should have refilled in approximately 5 minutes.

To ensure good fryer health and a safe environment, the fryer should be checked and adjusted periodically by qualified service personnel as part of a regular kitchen maintenance program.

### 5.7.3 Stainless Steel Care



**DO NOT let water splash into the tank of hot oil. It will splatter and can cause severe burns.**

All stainless steel fryer cabinet parts should be wiped regularly with hot, soapy water during the day, and with a liquid cleanser designed for stainless steel at the end of each day.

- A. Do not use steel wool, abrasive cloths, cleansers or powders.
- B. Do not use a metal knife, spatula or any other metal tool to scrape stainless steel! Scratches are almost impossible to remove.
- C. If it is necessary to scrape the stainless steel to remove any encrusted materials, soak the area first to soften the deposit, then use a wood or nylon scraper only.

# 1814G with FILTERQUICK™ SERIES GAS FRYERS

## CHAPTER 6: OPERATOR TROUBLESHOOTING

---

### 6.1 Introduction

This chapter provides an easy reference guide to some of the common problems that may occur during the operation of your equipment. The troubleshooting guides that follow are intended to help you correct, or at least accurately diagnose, problems with your equipment. Although the chapter covers the most common problems reported, you may encounter problems that are not covered. In such instances, the Frymaster Technical Services staff will make every effort to help you identify and resolve the problem.

When troubleshooting a problem, always use a process of elimination starting with the simplest solution and working through to the most complex. Most importantly, always try to establish a clear idea of why a problem has occurred. Part of your corrective action involves taking steps to ensure that it doesn't happen again. If a controller malfunctions because of a poor connection, check all other connections while you're at it. Always keep in mind that failure of a small component may often be indicative of potential failure or incorrect functioning of a more important component or system.

If you are in doubt as to the proper action to take, do not hesitate to call the Frymaster Technical Service Department or your local Frymaster Factory Authorized Servicer for assistance.

#### ***Before calling a servicer or the Frymaster HOTLINE (1-800-551-8633):***

- **Verify that electrical cords are plugged in and that circuit breakers are on.**
- **Verify that gas line quick-disconnects are properly connected.**
- **Verify that any gas line cutoff valves are open.**
- **Verify that frypot drain valves are fully closed.**
- **Have your fryer's model and serial numbers ready to give to the technician assisting you.**

 **DANGER**

**Hot oil will cause severe burns. Never attempt to move this appliance when filled with hot cooking oil or to transfer hot cooking oil from one container to another.**

 **DANGER**

**This equipment should be unplugged when servicing, except when electrical circuit tests are required. Use extreme care when performing such tests.**

**This appliance may have more than one electrical power supply connection point. Disconnect all power cords before servicing.**

**Inspection, testing, and repair of electrical components should be performed by an authorized servicer only.**

## 6.2 Troubleshooting Fryers

### 6.2.1 Controller and Heating Problems

PROBLEM	PROBABLE CAUSES	CORRECTIVE ACTION
<b>No display on the controller.</b>	<ul style="list-style-type: none"> <li>A. Master power switch is not turned on.</li> <li>B. No power to fryer.</li> <li>C. Failed controller or other component</li> </ul>	<ul style="list-style-type: none"> <li>A. Ensure the master power switch under the control box is switched on.</li> <li>B. Verify that the fryer is plugged in and that the circuit breaker is not tripped.</li> <li>C. Call your FAS for assistance.</li> </ul>
<b>Controller displays HEATING FAILURE.</b>	Air in the lines; Gas valve off, failed controller, failed transformer, open high-limit thermostat.	It is normal for this message to appear during startup if the lines have air in them. Cycle the fryer on and off a few times to purge the lines of air. Check that the gas valve is on. If it continues, shut the fryer down and call your FAS for assistance.
<b>Controller displays IS VAT FULL? YES NO</b> during a cook or in idle mode with an audible alarm.	<ul style="list-style-type: none"> <li>A. An error has occurred due to carbon buildup on oil level float switch sensor.</li> <li>B. CAN communication issues, component failure issues.</li> </ul>	<ul style="list-style-type: none"> <li>A. If answering yes directs to IS OIL SENSOR CLEAN? CONFIRM, clean the oil level float switch with a scratch pad and soft power cycle the controller.</li> <li>B. If the issue persists contact your FAS for assistance.</li> </ul>
<b>Controller displays IS OIL SENSOR CLEAN? CONFIRM</b> during a cook or in idle mode with an audible alarm.	<ul style="list-style-type: none"> <li>A. The oil level float switch may be coated with caramelized oil, sediment or crumbs.</li> <li>B. CAN communication issues, component failure issues.</li> </ul>	<ul style="list-style-type: none"> <li>A. Clean oil level float switch with scratch pad ensuring that it moves freely up and down.</li> <li>B. If the issue persists contact your FAS for assistance.</li> </ul>
<b>Controller displays CHANGE FILTER PAPER?</b>	Daily filter paper change prompt has occurred or filtration error has occurred.	Press ▲ (YES), follow prompts and change the filter paper.
<b>Fryer repeatedly cycles on and off when first started.</b>	Fryer is in melt cycle.	This is normal operation. This will continue until the fryer temperature reaches 180°F (82°C).
<b>Pilot will not ignite; no evidence of gas at pilot burner.</b>	<ul style="list-style-type: none"> <li>A. Gas valve is closed.</li> <li>B. Pilot is blocked.</li> <li>C. Burner contamination.</li> </ul>	<ul style="list-style-type: none"> <li>A. Check that gas valve is open and gas is present at the gas valve. Ensure that any shut off valves behind fryer are open.</li> <li>B. Check pilot burner orifice for dirt or lint.</li> <li>C. Contact your FAS for service.</li> </ul>
<b>Pilot burner ignites but will not remain lit.</b>	<ul style="list-style-type: none"> <li>A. Improper pilot flame.</li> <li>B. Connection issue.</li> </ul>	<ul style="list-style-type: none"> <li>A. Contact your FAS for service.</li> <li>B. Contact your FAS for service.</li> </ul>
<b>Main burner will not come "ON"; gas not detected at main burner.</b>	<ul style="list-style-type: none"> <li>A. Gas valve is not turned on.</li> <li>B. Pilot is not ignited.</li> <li>C. Oil level float switch stuck down</li> <li>D. High limit switch tripped.</li> <li>E. High limit defective.</li> <li>F. Gas valve defective.</li> </ul>	<ul style="list-style-type: none"> <li>A. Turn the gas valve knob to the <b>ON</b> position.</li> <li>B. Check that the pilot is ignited and is operating properly.</li> <li>C. Ensure the oil level float switch is clean and moves freely up and down the shaft.</li> <li>D. Press high limit switch reset under control box.</li> <li>E. Contact your FAS for service.</li> <li>F. Contact your FAS for service.</li> </ul>

<b>PROBLEM</b>	<b>PROBABLE CAUSES</b>	<b>CORRECTIVE ACTION</b>
<b>Float switch in upper position but no power to main valve.</b>	Relay or time delay relay in rear transformer box is defective.	Contact your FAS for service.
<b>Main burner flames are small and appear lazy; oil does not come up to temperature quickly.</b>	Improper gas pressure.	Contact your FAS for service.
<b>Fryer does not heat.</b>	<ul style="list-style-type: none"> <li>A. Oil level float switch stuck.</li> <li>B. Gas valve is not turned on.</li> <li>C. Manual gas shut off valve closed.</li> <li>D. Improperly connected quick disconnect fitting on gas line.</li> <li>E. Ignition module issue</li> </ul>	<ul style="list-style-type: none"> <li>A. Ensure the oil level float switch is clean and moves freely up and down.</li> <li>B. Turn the gas valve knob to the <b>ON</b> position.</li> <li>C. Verify that any in-line manual shut off and gas main valve is open.</li> <li>D. Verify that the quick-disconnect fitting on the flexible gas line is firmly connected to the fryer.</li> <li>E. Contact your FAS for service.</li> </ul>
<b>Fryer is operating normally, but recovery is slow when cooking.</b>	Improper gas pressure.	Contact your FAS for service.
<b>Fryer is operating normally, but produces a popping sound when burners ignite.</b>	Dirty or obstructed gas valve vent tube (non-CE fryers only).	Clean per instructions in Chapter 5 of this manual.
<b>Signs of excessive temperature; oil scorches and quickly becomes discolored.</b>	<ul style="list-style-type: none"> <li>A. Improper gas pressure.</li> <li>B. Oil used is of inferior quality and/or oil has been used too long.</li> <li>C. Dirty frypot.</li> </ul>	<ul style="list-style-type: none"> <li>A. Contact your FAS for service.</li> <li>B. Replace oil.</li> <li>C. Ensure frypot is clean when refilling with new oil.</li> </ul>
<b>Fryer will not reach the temperature setting and/or runs erratically.</b>	<ul style="list-style-type: none"> <li>A. Incorrect location of temperature sensor probe or defective temperature sensor.</li> <li>B. Loose wiring/wire connection.</li> </ul>	<ul style="list-style-type: none"> <li>A. Contact your FAS for service.</li> <li>B. Contact your FAS for service.</li> </ul>
<b>Fryer oil temperature cannot be controlled; fryer runs at high-limit temperature.</b>	Defective temperature probe.	Contact your FAS for service.

### 6.2.2 Error Messages and Display Problems

<b>PROBLEM</b>	<b>PROBABLE CAUSES</b>	<b>CORRECTIVE ACTION</b>
<b>Controller displays <i>LOW TEMP.</i></b>	Frypot temperature has dropped more than 30°F (17°C) lower than setpoint in idle mode or 45°F (25°C) in cook mode.	This display is normal for a short while if a large batch of frozen product is added to the frypot or if the fryer is not heating properly. If the issue persists call your FAS for assistance.
<b>Controller displays <i>HOT HI- 1.</i></b>	Frypot temperature is more than 410°F (210°C) or, in CE countries, 395°F (202°C).	Shut the fryer down immediately and call your FAS for assistance.

<b>Controller displays HI TEMP.</b>	Frypot temperature is more than 40 °F (4°C) above setpoint.	Press the power button to turn off fryer and let cool before returning power to fryer. If issue continues call your FAS for assistance.
<b>Controller displays RECOVERY FAULT/ YES and alarm sounds.</b>	Recovery time exceeded maximum time limit.	Clear error and silence the alarm by pressing the ▲ (YES) button. Maximum recovery time is 2:25. If the error continues call your FAS for assistance.
<b>Controller display is in wrong temperature scale (Fahrenheit or Celsius).</b>	Incorrect display option programmed.	Fryers using the FilterQuick™ controller can toggle between F° to C° by pressing the ✓ button until Product setup is displayed. Press ► to scroll to Tech Mode and press ✓. Enter 1658. Press the scan button. The controller displays OFF. Turn the controller on to check temperature. If the desired scale is not displayed, repeat.
<b>Controller displays HIGH LIMIT FAILURE DISCONNECT POWER.</b>	Failed high limit	Shut the fryer down immediately and call your FAS for assistance.
<b>Controller displays TEMP PROBE FAILURE</b>	Problem with the temperature measuring circuitry including the probe or damaged controller wiring harness or connector.	Shut the fryer down and call your FAS for assistance.
<b>Controller displays SERVICE REQUIRED</b> followed by an error message.	An error has occurred which may require a service technician.	Press the ▲ (YES) button if the issue is fixed or press the ▼ (NO) button to continue cooking and call your FAS for assistance. In some cases, cooking may not be available.

### 6.2.3 Basket Lift Problems

PROBLEM	PROBABLE CAUSES	CORRECTIVE ACTION
<b>Basket lift movement is jerky and/or noisy.</b>	Basket lift rods need lubrication.	Apply a light coating of Lubriplate™ or similar lightweight white grease to the rod and bushings.

### 6.2.4 Filtration Problems

PROBLEM	PROBABLE CAUSES	CORRECTIVE ACTION
<b>Fryer filters after each cook cycle.</b>	Filter prompt setting incorrect.	Change the filter prompt setting.
<b>Filter menu functions won't start or controller displays WAIT FOR FILTER or FILTER BUSY.</b>	<ul style="list-style-type: none"> <li>A. Another function is still in process.</li> <li>B. Temperature too low or controller displays OFF.</li> <li>C. MIB has not cleared checking system.</li> <li>D. Messages or errors on other controllers.</li> <li>E. Filter pan not fully engaged.</li> </ul>	<ul style="list-style-type: none"> <li>A. Wait until the previous function ends to start another filtration cycle.</li> <li>B. Ensure fryer is at setpoint before starting; ensure the controller is ON.</li> <li>C. Wait one minute and try again.</li> <li>D. Clear messages and errors on other controllers.</li> <li>E. Ensure the filter pan is in position and fully inserted into the fryer and "A" is displayed on the MIB board.</li> </ul>

<b>PROBLEM</b>	<b>PROBABLE CAUSES</b>	<b>CORRECTIVE ACTION</b>
<b>Controller displays FLT DLYD OR POL DLYD.</b>	Another function is in process or the filter has been bypassed.	Wait until the previous function ends to start another filtration cycle or select "YES" to "FILTER NOW?" if present on another controller.
<b>Filter pump won't start or pump stops during filtering.</b>	A. Power cord is not plugged in or circuit breaker is tripped. B. Pump motor has overheated causing the thermal overload switch to trip. C. Blockage in filter pump.	A. Verify that the power cord is fully plugged in and the circuit breaker is not tripped. B. If the motor is too hot to touch for more than a few seconds, the thermal overload switch has probably tripped. Allow the motor to cool at least 45 minutes then press the Pump Reset Switch (see page 4-5). C. Call your FAS for assistance.
<b>Filter Pump runs, but oil return is very slow.</b>	A. Improperly installed or prepared filter pan components or cold oil. B. Worn or missing O-rings. C. Plugged pre-filter screen.	A. Remove the oil from the filter pan and replace the filter paper, ensuring that the filter screen is in place <b>under</b> the paper. B. Verify that O-rings are present and in good condition on filter pan connection fitting. C. Check and clean the pre-filter screen.
<b>Controller displays OIL IN DRAIN PAN / CONFIRM</b>	Drain valve open or possibility that oil is in drain pan.	Press ▲ (CONFIRM) and follow directions for <b>FILL VAT FROM DRAIN PAN.</b>
<b>Drain valve or return valve stays open.</b>	A. AIF board has failed. B. Actuator has failed.	Call your FAS for assistance.
<b>Controller displays INSERT PAN.</b>	A. Filter pan is not fully set into fryer. B. Missing filter pan magnet. C. Defective filter pan switch.	A. Pull filter pan out and fully reinsert into fryer. B. Ensure the filter pan magnet is in place and replace if missing. C. If the filter pan magnet is fully against the switch and computer continues to display <b>INSERT PAN</b> , switch is possibly defective. Call your FAS for assistance
<b>Semi-automatic filtration won't start.</b>	A. Oil level too low. B. Check that MIB board is not in manual mode. C. Check to see that the MIB cover is not damaged and depressing the buttons. D. Filter relay has failed.	A. Ensure oil level is above the top oil level sensor. B. Ensure MIB board is in "A" automatic mode. Power cycle the fryer. C. Remove and replace cover and see if filtration will start. D. Call your FAS for assistance.
<b>Controller displays OIL SENSOR FAIL.</b>	A. Oil float switch may be sticking. B. Oil float switch may have failed.	A. Clean the oil float switch ensuring it moves freely up and down the shaft. B. Call your FAS for assistance.
<b>Controller displays IS VAT FULL? YES NO after a filter function.</b>	A. Normal after some filter menu functions when filling. B. An error has occurred due to sediment, carbon buildup or crumbs on oil float switch. C. All the oil may not have returned during a filter function due to dirty or clogged filter paper, clogged filter pump, filter pump thermal overload, improperly installed filter pan components, worn or missing O-rings, cold oil	A. Otherwise press ▲ (YES) if the vat is full, otherwise press ▼ (NO) and follow prompts. B. If answering yes directs to clean oil sensor, clean oil level float switch with a scratch pad and retry. C. Check to ensure that the probable causes are remedied. Follow the prompts to refill the vat.

PROBLEM	PROBABLE CAUSES	CORRECTIVE ACTION
	or an actuator problem.	
<b>Controller displays 15 DRAIN CLEAR?</b>	Drain is clogged and oil failed to drain.	Clear drain with Fryers Friend and press ▲ (YES) button. Filtration will resume.

### 6.2.5 Auto Top-Off Problems

PROBLEM	PROBABLE CAUSES	CORRECTIVE ACTION
<b>Frypots top off cold.</b>	Incorrect setpoint.	Ensure setpoint is correct.
<b>Frypots won't top off.</b>	<ul style="list-style-type: none"> <li>A. Fryer temperature too low.</li> <li>B. Oil is too cold.</li> <li>C. Oil saddle reservoir is out of oil.</li> <li>D. Crumb build up around sensor.</li> <li>E. Filter error exists.</li> <li>F. Disconnected or clogged quick disconnect.</li> <li>G. Service required error exists.</li> </ul>	<ul style="list-style-type: none"> <li>A. Fryer temperature must be at setpoint.</li> <li>B. Ensure that the oil in the oil saddle reservoir is above 70°F (21°C).</li> <li>C. Ensure the oil saddle reservoir is not out of oil. Fill the oil saddle reservoir and press the ▲ button when prompted and press and hold the ORANGE reset button for five (5) seconds to reset top off system.</li> <li>D. Clean crumbs from opening surrounding ATO sensor.</li> <li>E. Clear filter error properly. If problem persists call your FAS for assistance.</li> <li>F. Check quick disconnect on bottom of oil saddle ensuring it is properly connected. Remove and clean quick disconnect.</li> <li>G. If problem persists call your FAS for assistance.</li> </ul>
<b>One vat doesn't top off.</b>	<ul style="list-style-type: none"> <li>A. Filter error exists.</li> <li>B. Service required error exists</li> <li>C. Solenoid, pump, pin issue, RTD or ATO issue.</li> </ul>	<ul style="list-style-type: none"> <li>A. Clear filter error properly. If problem persists call your FAS for assistance.</li> <li>B. Call your FAS for assistance.</li> <li>C. Call your FAS for assistance.</li> </ul>
<b>Controller displays TOPOFF OIL EMPTY / YES NO</b>	Top off system out of oil.	Press the ▲ (YES) button and follow the prompts to fill top off system with oil. Once the oil saddle reservoir is filled, press and hold the orange reset button for five (5) seconds to reset top off system.

### 6.2.6 Error Log Codes (For FilterQuick™ Controller Only)

CODE	ERROR MESSAGE	EXPLANATION
E03	ERROR TEMP PROBE FAILURE	Temp probe reading out of range
E04	HI 2 BAD	High limit reading is out of range.
E05	HOT HI 1	High limit temperature is past more than 410°F (210°C), or in CE countries, 395°F (202°C)
E06	HEATING FAILURE	A component has failed such as controller, interface board, gas valve, ignition module or open-high limit.
E07	ERROR MIB SOFTWARE	Internal MIB software error
E08	ERROR ATO BOARD	ATO board connection lost; ATO board failure



CODE	ERROR MESSAGE	EXPLANATION
E09	ERROR PUMP NOT FILLING	Dirty paper/pad and it needs changed or it was bypassed; filter pump problem
E10	ERROR DRAIN VALVE NOT OPEN	Drain valve was trying to open and confirmation is missing
E11	ERROR DRAIN VALVE NOT CLOSED	Drain valve was trying to close and confirmation is missing
E12	ERROR RETURN VALVE NOT OPEN	Return valve was trying to open and confirmation is missing
E13	ERROR RETURN VALVE NOT CLOSED	Return valve was trying to close and confirmation is missing
E14	ERROR AIF BOARD	MIB detects AIF missing; AIF board failure
E15	ERROR MIB BOARD	Cooking controller detects MIB connections lost; Check software version on each controller. If versions are missing, check CAN connections between each controller; MIB board failure
E16	ERROR AIF PROBE	AIF RTD reading out of range
E17	ERROR ATO PROBE	ATO RTD reading out of range
E20	INVALID CODE LOCATION	SD card removed during update
E21	FILTER PAPER PROCEDURE ERROR (Change Filter Paper)	25 hour timer has expired or a dirty filter may be causing an incomplete filtration.
E22	OIL IN PAN ERROR	Oil may be present in the filter pan.
E23	CLOGGED DRAIN (Gas)	Vat did not empty during filtration
E24	OIL LEVEL SENSOR FAILED (Gas)	Oil level sensor failed.
E25	RECOVERY FAULT	Recovery time exceeded maximum time limit. Recovery time should not exceed 2:25 for gas.
E27	LOW TEMP ALARM	Oil temperature has dropped 30°F (17°C) lower than setpoint in idle mode or 45°F (25°C) in cook mode. (This message may appear if a product is dropped and the start cook button is not pressed immediately or if too large of cook loads are dropped.)
E28	HIGH TEMP ALARM	Oil temperature has risen 40°F (4°C) higher than the setpoint. If temperature continues to rise, the high limit will shut the burner off when temperature reaches 425°F (218°C) Non-CE or 395°F (202°C) CE.
E70	OQS TEMP HIGH	Oil temperature is too high for a valid OQS reading. Filter at a temperature between 300°F (149°C) and 375°F (191°C).
E71	OQS TEMP LOW	Oil temperature is too low for a valid OQS reading. Filter at a temperature between 300°F (149°C) and 375°F (191°C).
E72	TPM RANGE LOW	The TPM is too low for a valid OQS reading. The incorrect oil type may be selected in the setup menu. The sensor may not be calibrated for the oil type. See oil type chart. If issue continues contact a FAS.
E73	TPM RANGE HIGH	The TPM reading is too high for a valid OQS reading. Dispose the oil.
E74	OQS ERROR	The OQS has an internal error. If issue continues contact a FAS.
E75	OQS AIR ERROR	The OQS is detecting air in the oil. Check the O-rings and check/tighten prescreen filter to ensure no air is entering the OQS sensor. If issue

CODE	ERROR MESSAGE	EXPLANATION
		continues contact a FAS.
E76	OQS ERROR	The OQS sensor has a communication error. Check connections to the OQS sensor. Power cycle the entire fryer battery. If issue continues contact a FAS.

### 6.2.7 OQS (Oil Quality Sensor) Troubleshooting

Problem	Corrective Action
<b>No TPM results displayed.</b>	<p><b>Check the following items and perform another OQS filter.</b></p> <ul style="list-style-type: none"> <li>• Ensure the vat is at setpoint temperature.</li> <li>• Inspect the pre-screen filter and ensure it is screwed in tightly.</li> <li>• Inspect the O-rings on the filter pan and ensure they are both present and that they are not missing, cracked or worn. If so replace them.</li> <li>• Ensure the filter paper is not clogged and clean filter paper is used. Did the vat refill the first time for the previous filter? If not change the filter paper.</li> </ul>

# 1814G with FILTERQUICK™ SERIES GAS FRYER

## APPENDIX A: BULK OIL INSTRUCTIONS

### A.1.1 Bulk Oil Systems

Bulk oil systems have large oil storage tanks, typically located in the rear of the restaurant, that are connected to a rear manifold on the fryer. Waste oil is pumped from the fryer, via a fitting located on the rear of the fryer labeled DISPOSE (see Figure 1), to the disposal tanks and fresh oil is pumped from the tanks, thru the fitting located on the rear of the fryer labeled FILL, to the fryer (see Figure 2). Connect the bulk oil connections to plug located on the rear of the fryer (see Figure 3). The wiring diagram is located on the next page.

It is imperative that the fryer system be completely power cycled after changing any fresh or waste oil settings.

The 1814G with FilterQuick™ fryers, equipped for use with bulk oil systems, have an onboard fresh oil reservoir that may or may not be supplied by the bulk oil provider. For fryers batteries with two or more vats, remove the cap and insert the standard fitting into the jug with the metal cap resting on the lip of the jug. The oil is pumped in and out of the saddle reservoir, through the same fitting (see Figure 4).



Figure 4

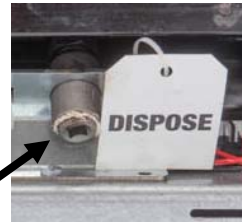

Waste Oil Connection  
Figure 1



Figure 2

Fresh Oil Connection

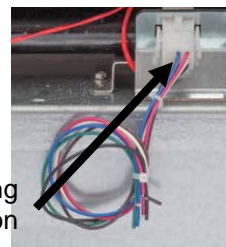

Bulk wiring connection

Figure 3

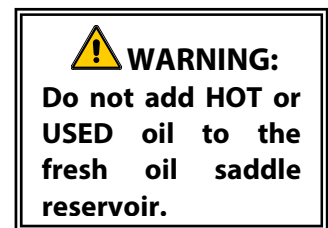

The momentary switch used to reset the ATO system is also used to fill the oil saddle in a fresh bulk oil system. After clearing the TOP OFF EMPTY display, pressing and holding the orange momentary switch, allows the operator to fill the oil saddle from the bulk oil storage tank (see Figure 5).

To fill the oil saddle, press and hold the reset button until the reservoir is full, then release.\*

**NOTE: Do NOT overfill the oil saddle.**

For instructions on filling the vat from bulk, see the FilterQuick Controller Manual Section 1.9.8.

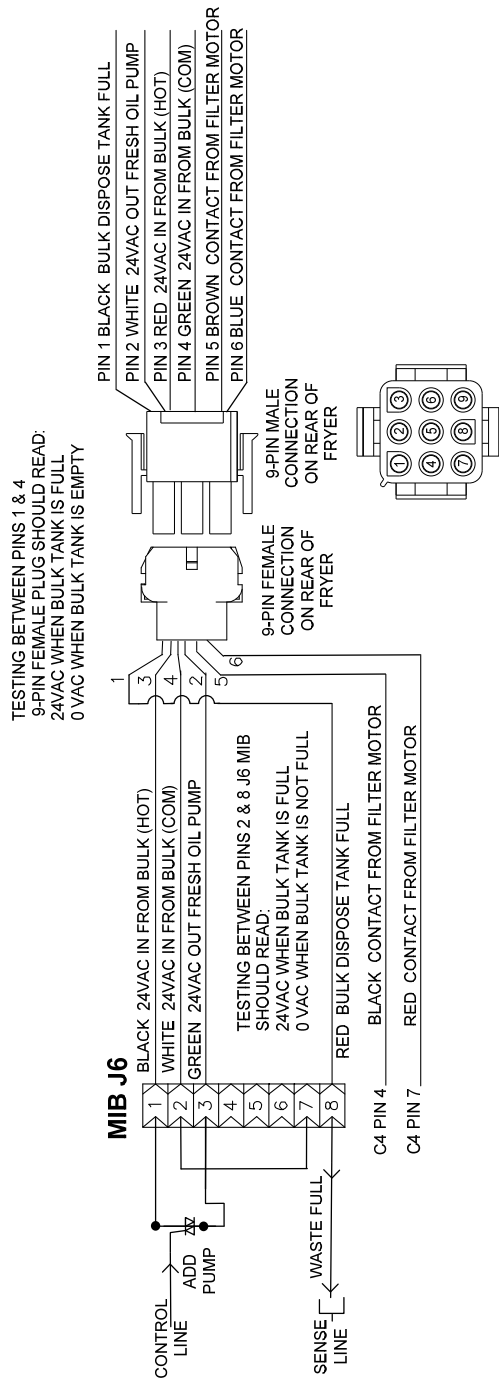

Figure 5

\* **NOTE:** It takes approximately twelve seconds from the time the fill oil saddle button is pressed until the fresh bulk oil pump starts. It may take up to 20 seconds before the level in the reservoir begins to rise. Typically it takes approximately three minutes to fill the reservoir. It takes approximately four minutes to fill the vat.

## A.1.2 Bulk Oil Wiring

### BULK OIL WIRING







### **⚠ WARNING**

The FilterQuick™ fryer will **ONLY** operate with bulk oil systems that have a three-pole float switch. If the float switch is the older two-pole switch, call the bulk oil provider. These float switches are polarity specific which may short to ground and damage an MIB board.

**THIS PAGE INTENTIONALLY LEFT BLANK**

**WELBILT®***Bringing innovation to the table***WWW.WELBILT.COM**

Welbilt provides the world's top chefs, and premier chain operators or growing independents with industry leading equipment and solutions. Our cutting-edge designs and lean manufacturing tactics are powered by deep knowledge, operator insights, and culinary expertise. All of our products are backed by KitchenCare® – our aftermarket, repair, and parts service.

 CLEVELAND  
CONVOTHERM® DELFIELD®  
FITKITCHEN™ FRYMASTER®  
GARLAND KOLPAK®  
LINCOLN MANITOWOC®  
MERCO® MERRYCHEF®  
MULTIPLEX®